

# ThinkPad P14s Gen 5 and ThinkPad P16s Gen 3 User Guide

Lenovo  
ThinkPad

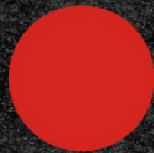

Lenovo

## **Read this first**

Before using this documentation and the product it supports, ensure that you read and understand the following:

- *Safety and Warranty Guide*
- *Setup Guide*
- [Generic Safety and Compliance Notices](#)

**Second Edition (July 2024)**

**© Copyright Lenovo 2024.**

LIMITED AND RESTRICTED RIGHTS NOTICE: If data or software is delivered pursuant to a General Services Administration "GSA" contract, use, reproduction, or disclosure is subject to restrictions set forth in Contract No. GS-35F-05925.

# Contents

## Discover your Lenovo notebook. . . . .iii

### Chapter 1. Meet your computer. . . . . 1

|                                       |   |
|---------------------------------------|---|
| Front view . . . . .                  | 1 |
| Side view . . . . .                   | 4 |
| Bottom view . . . . .                 | 7 |
| Features and specifications . . . . . | 9 |
| USB specifications. . . . .           | 9 |

### Chapter 2. Get started with your computer. . . . . 11

|  |    |
|--|----|
| Set up your computer . . . . .   | 11 |
| Turn on the computer. . . . .  | 11 |
| Complete the operating system setup . . . . .  | 11 |
| Access networks . . . . .  | 12 |
| Connect to Wi-Fi networks. . . . .   | 12 |
| Turn on Airplane mode . . . . .  | 12 |
| Connect to the wired Ethernet . . . . .  | 13 |
| Connect to a cellular network (for selected models of ThinkPad P16s Gen 3) . . . . . | 13 |
| Interact with your computer . . . . .  | 14 |
| Use the keyboard shortcuts . . . . .   | 14 |
| Use the TrackPoint pointing device . . . . .   | 15 |
| Use the Trackpad . . . . .   | 17 |
| Use the touch screen (for selected models) . . . . .                                 | 20 |
| Connect to an external display . . . . .   | 23 |

### Chapter 3. Explore your computer . . . . . 25

|  |    |
|--|----|
| Lenovo apps . . . . .  | 25 |
| Lenovo Commercial Vantage (for selected models) . . . . .                | 25 |
| Lenovo View (for selected models). . . . .                               | 25 |
| TrackPoint Quick Menu . . . . .  | 27 |
| Color calibration (for selected models of ThinkPad P16s Gen 3) . . . . . | 29 |
| Switch between color profiles . . . . .                                  | 29 |
| Install or restore color profiles . . . . .                              | 29 |
| Intelligent Cooling . . . . .  | 30 |
| Switch among modes . . . . .   | 30 |
| Install the Intelligent Thermal Solution (ITS) drivers . . . . .         | 30 |
| Cool and Quiet on lap . . . . .  | 31 |
| Manage power . . . . .   | 31 |
| Check the battery status . . . . .                                       | 31 |
| Charge the computer with ac power . . . . .                              | 31 |
| Maximize the life of the battery . . . . .                               | 32 |
| Charge your computer with P-to-P 2.0 charging function . . . . .         | 32 |

|  |    |
|--|----|
| Change the power settings . . . . .              | 32 |
| Transfer data . . . . .                          | 33 |
| Connect to a Bluetooth device . . . . .          | 33 |
| Use a smart card (for selected models) . . . . . | 33 |

### Chapter 4. Secure your computer and information . . . . . 35

|  |    |
|--|----|
| Lock the computer . . . . .  | 35 |
| Log in with fingerprint recognition . . . . .  | 35 |
| Log in with facial recognition. . . . .  | 36 |
| Lock on leave function (for selected models) . . . . .                                 | 36 |
| Change the settings from the Vantage app . . . . .                                     | 37 |
| Change the settings from the UEFI BIOS . . . . .                                       | 37 |
| Protect data against power loss . . . . .  | 37 |
| USB-C Restricted Mode . . . . .  | 37 |
| UEFI BIOS passwords . . . . .  | 38 |
| Password types . . . . .   | 38 |
| Set, change, or remove a password . . . . .  | 39 |
| Associate your fingerprints with passwords (for selected models) . . . . .             | 40 |
| FIDO (Fast Identity Online) authentication. . . . .                                    | 41 |
| Register FIDO2 USB device in ThinkShield Passwordless Power-On Device Manager. . . . . | 41 |
| Log in to the System with Passwordless Power-On Authentication . . . . .               | 41 |

### Chapter 5. Configure advanced settings. . . . . 43

|   |    |
|---|----|
| UEFI BIOS . . . . .                                       | 43 |
| Enter the UEFI BIOS menu. . . . .                         | 43 |
| Navigate the UEFI BIOS menu . . . . .                     | 43 |
| Customize BIOS Defaults . . . . .                         | 43 |
| Reset system to factory defaults . . . . .                | 44 |
| Recover the UEFI BIOS . . . . .                           | 44 |
| Detect memory retraining . . . . .                        | 45 |
| Cloud bare metal recovery (for selected models) . . . . . | 45 |
| Update the UEFI BIOS . . . . .                            | 46 |
| Install a Windows operating system and drivers . . . . .  | 46 |
| Install device drivers . . . . .                          | 47 |

### Chapter 6. CRU replacement . . . . . 49

|  |    |
|--|----|
| CRU list . . . . .                     | 49 |
| Before you replace any CRU. . . . .    | 49 |
| Disable Fast Startup . . . . .         | 50 |
| Disable the built-in battery . . . . . | 50 |
| Replace a CRU . . . . .                | 50 |
| Base cover assembly . . . . .          | 50 |

|  |           |   |           |
|--|-----------|---|-----------|
| Wireless WAN module (for selected models of ThinkPad P16s Gen 3) . . . . . | 52        | Recover your Windows operating system. . . . .                    | 67        |
| Memory module. . . . .   | 53        | Self-help resources . . . . .                                     | 68        |
| M.2 solid-state drive and its bracket (for selected models) . . . . .      | 55        | Windows label . . . . .   | 68        |
| <b>Chapter 7. Help and support . . . . .</b>                               | <b>59</b> | Call Lenovo . . . . .   | 68        |
| Find your service QR code and serial number . . . . .                      | 59        | Before you contact Lenovo . . . . .                               | 69        |
| Frequently asked questions . . . . .                                       | 60        | Lenovo Customer Support Center. . . . .                           | 69        |
| Error messages . . . . .   | 63        | Purchase accessories or additional services . . . . .             | 70        |
| Battery-charge LED indicator diagnosis . . . . .                           | 63        | Accessibility features. . . . .                                   | 70        |
| Lenovo Memory Self Repair (for Intel models only) . . . . .                | 65        | <b>Appendix A. Compliance information. . . . .</b>                | <b>73</b> |
| Diagnose and troubleshoot your computer . . . . .                          | 66        | <b>Appendix B. Notice for USB connector name update . . . . .</b> | <b>77</b> |
| Troubleshoot and diagnose at Lenovo Support Web site . . . . .             | 66        | <b>Appendix C. Notices and trademarks. . . . .</b>                | <b>79</b> |
| Hardware scan . . . . .  | 67        |   |           |
| UEFI Diagnostics tool. . . . .   | 67        |   |           |



---

## Discover your Lenovo notebook

**Thank you for choosing a Lenovo® notebook! We are dedicated to delivering the best solution to you.**

Before starting your tour, please read the following information:

- Illustrations in this documentation might look different from your product.
- Depending on the model, some optional accessories, features, software programs, and user interface instructions might not be applicable to your computer.
- Documentation content is subject to change without notice. To get the latest documentation, go to <https://pcsupport.lenovo.com>.



---

# Chapter 1. Meet your computer

This chapter introduces the appearance, features and specifications of your computer.

---

## Front view









Have a quick glance at the front view of your computer.

### ThinkPad P14s Gen 5



## ThinkPad P16s Gen 3



| Item  | Description                          | Item  | Description               |
|---|--------------------------------------|---|---------------------------|
|  | Microphone                           |  | Infrared camera / Camera  |
|  | Webcam privacy shutter               |  | Touch screen*             |
|  | Power button with fingerprint reader |  | TrackPoint pointing stick |
|  | TrackPoint Three Buttons             |  | Trackpad                  |

\* for selected models



### Webcam privacy shutter

Slide the webcam privacy shutter to cover or uncover the camera lens. It is designed to protect your privacy.

**Related topics**





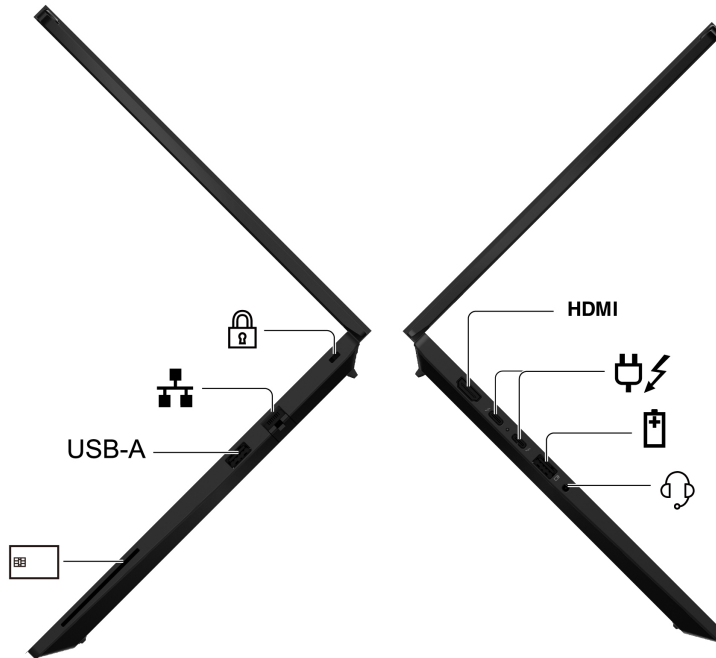

- “Use the TrackPoint pointing device” on page 15
- “Use the Trackpad” on page 17
- “Use the touch screen (for selected models)” on page 20
- “Log in with fingerprint recognition” on page 35
- “Log in with facial recognition” on page 36
- “Lock on leave function (for selected models)” on page 36

## Side view

Have a quick glance at ports on both sides of your computer.

### ThinkPad P14s Gen 5









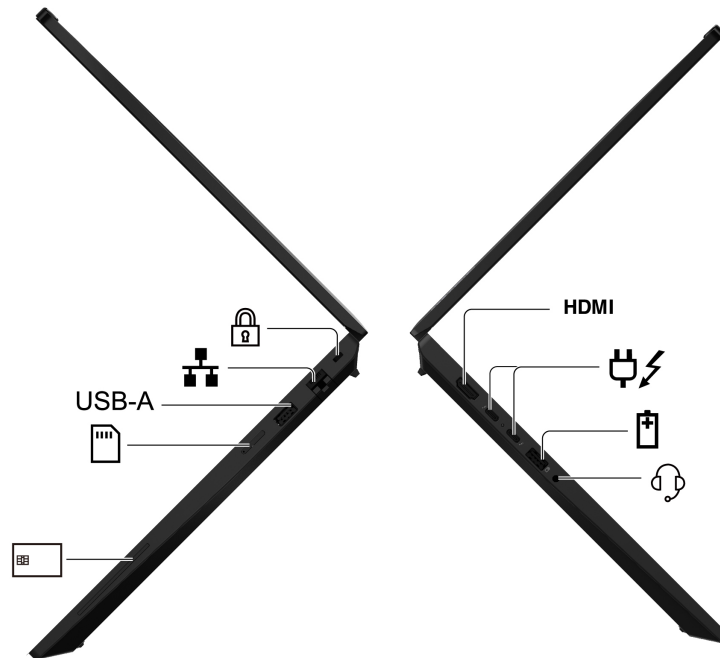

| Item  | Description                             | Item  | Description                                |
|---|---|---|--|
|  | Security-lock slot                      |  | Ethernet connector                         |
| USB-A   | USB-A® connector (USB 5Gbps)            |  | Smart-card slot*                           |
|  | Audio connector                         |  | USB-A connector (USB 5Gbps, Always On USB) |
|  | USB-C® power connector (Thunderbolt™ 4) | HDMI  | HDMI™ connector                            |

\* for selected models



## ThinkPad P16s Gen 3



| Item  | Description                                | Item  | Description                           |
|---|--|---|---------------------------------------|
|  | Security-lock slot                         |  | Ethernet connector                    |
| USB-A   | USB-A connector (USB 5Gbps)                |  | Nano-SIM-card tray*                   |
|  | Smart-card slot*                           |  | Audio connector                       |
|  | USB-A connector (USB 5Gbps, Always On USB) |  | USB-C power connector (Thunderbolt 4) |
| <b>HDMI</b>   | HDMI connector                             |   |                                       |

\* for selected models

**Note:** For more information about the USB connector name update, see Appendix B “Notice for USB connector name update” on page 77.

### Statement on USB transfer rate

Depending on many factors such as the processing capability of the host and peripheral devices, file attributes, and other factors related to system configuration and operating environments, the actual transfer rate using the various USB connectors on this device will vary and will be slower than the data rate listed in the connector name or below for each corresponding device.

| <b>USB device</b> | <b>Data rate (Gbps)</b> |
|-------------------|-------------------------|
| Thunderbolt 3     | 40                      |
| Thunderbolt 4     | 40                      |

### **Related topics**

- “USB specifications” on page 9
- “Connect to a cellular network (for selected models of ThinkPad P16s Gen 3)” on page 13
- “Connect to an external display” on page 23
- “Manage power” on page 31
- “Use a smart card (for selected models)” on page 33
- “Lock the computer” on page 35

---

## Bottom view

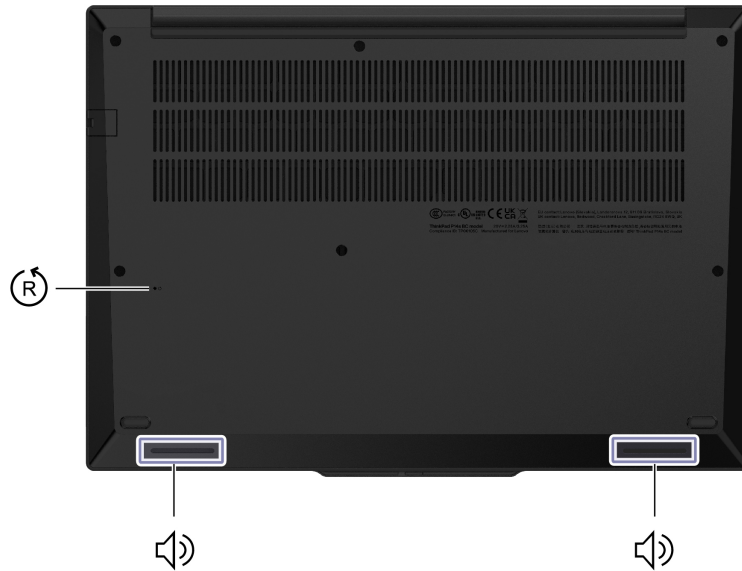

Have a quick glance at the bottom part of your computer.

### ThinkPad P14s Gen 5

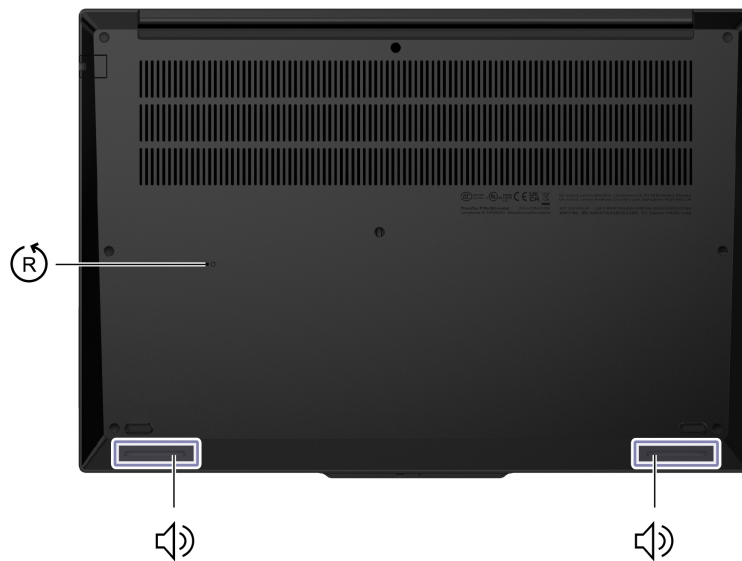

### ThinkPad P16s Gen 3



| Item  | Description          | Item  | Description |
|---|----------------------|---|-------------|
|  | Emergency-reset hole |  | Speaker     |



## Emergency-reset hole

Emergency-reset hole can help you to recover computer when the computer stops responding and you cannot turn it off by pressing the power button. Do the following to reset your computer:

1. Disconnect your computer from ac power.
2. Insert a straightened paper clip into the hole to cut off power supply temporarily.
3. Connect your computer to ac power and then turn on your computer.

**Note:** If your computer is still no response, you can call Lenovo Customer Support Center to get further help.

### **CAUTION:**

**When the computer is operating, it should be placed on a hard and flat surface with its bottom area not in contact with user's bare skin. Under normal operating conditions, the temperature of the bottom surface will remain within an acceptable range as defined in IEC 62368-1, but such temperatures can still be high enough to cause discomfort or harm to the user if directly touched for over one minute at a time. As such, it is recommended that users avoid prolonged direct contact with the bottom of the computer.**

---

## Features and specifications

Get to know more hardware and software details of your computer.

| Specification     | Description  |
|-------------------|--|
| Memory            | Two slots, Double Data Rate 5 (DDR5) Small Outline Dual Inline Memory Module (SODIMM), up to 48 GB for each, up to 96 GB in total  |
| Storage device    | One slot, 2280 M.2 solid-state drive, up to 2 TB   |
| Audio             | <ul style="list-style-type: none"><li>• Dolby Atmos®</li><li>• Dolby Voice®</li></ul>  |
| Display           | <ul style="list-style-type: none"><li>• Color display with In-Plane Switching (IPS) technology</li><li>• Display ratio: 16:10</li><li>• Display resolution:<ul style="list-style-type: none"><li>– ThinkPad P14s Gen 5: 1920 x 1200 pixels, 2560 x 1600 pixels or 3072 x 1920 pixels</li><li>– ThinkPad P16s Gen 3: 1920 x 1200 pixels or 3840 x 2400 pixels</li></ul></li><li>• Multi-touch technology*</li></ul>         |
| Security features | <ul style="list-style-type: none"><li>• Face authentication</li><li>• Human presence detection*</li><li>• Fingerprint reader (integrated in power button)</li><li>• Lenovo View Privacy Guard*</li><li>• Lenovo View Privacy Alert*</li><li>• Trusted Platform Module (TPM)*</li></ul>   |
| Wireless features | <ul style="list-style-type: none"><li>• Bluetooth</li><li>• GPS (on wireless WAN model)*</li><li>• Wireless LAN</li><li>• Wireless WAN (4G)*</li></ul> <p><b>Note:</b> The 4G cellular service is provided by authorized mobile service carriers in some countries or regions. You must have a cellular plan from a service carrier to connect to the cellular network. The cellular data plan might vary by location.</p> |

\* for selected models

## USB specifications

Get to know more USB specifications.

**Note:** Depending on the model, some USB connectors might not be available on your computer.

| Connector name | Description |
|----------------|-------------|
|----------------|-------------|

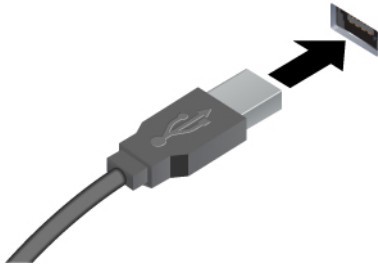

Connect USB-compatible devices, such as a USB keyboard, USB mouse, USB storage device, or USB printer.

- USB-A connector (Hi-Speed USB)
- USB-A connector (USB 5Gbps)
- USB-A connector (USB 10Gbps)

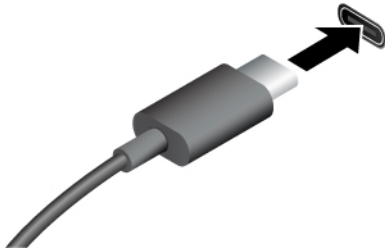

- Charge USB-C compatible devices with the output voltage and current of 5 V and 3 A.
- Connect to an external display:
  - USB-C to VGA: up to 1920 x 1200 pixels, 60 Hz
  - USB-C to DP: up to 7680 x 4320 pixels, 60 Hz
- Connect to USB-C accessories to help expand your computer functionality. To purchase USB-C accessories, go to <https://www.lenovo.com/accessories>.

- USB-C connector (USB 5Gbps)
- USB-C connector (USB 10Gbps)
- USB-C connector (Thunderbolt 3)
- USB-C connector (Thunderbolt 4)
- USB-C connector (USB4 40Gbps)
- USB-C connector (DP Alt mode DP 2.1)



---

## Chapter 2. Get started with your computer

This chapter introduces the instructions of setting up your computer, various ways to connect to networks, and to interact with your computer.

---

### Set up your computer

This section helps you to set up your computer and get it ready for use.

### Turn on the computer

Follow the instructions to turn on your computer.

- Step 1. Connect the power cord to the ac power adapter.
- Step 2. Connect the power adapter to your computer.
- Step 3. Plug the power cord into the ac power.
- Step 4. Press the power button to turn on your computer.

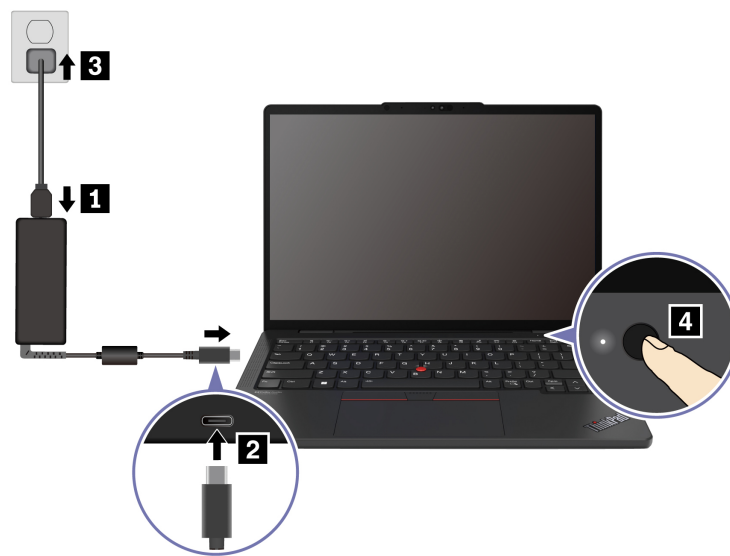

#### Notes:

- The appearance varies depending on the computer model.
- It is recommended to fully charge the computer when using it for the first time. Click the battery status icon at the bottom right of your desktop to check the battery status.

#### Related topics

- “Check the battery status” on page 31
- “Charge the computer with ac power” on page 31

### Complete the operating system setup

Before exploring your computer, you need to complete the operating system setup. The setup includes but is not limited to:

- Select the country or region.
- Connect to an available network.
- Accept the license agreement.
- Create a Microsoft account or log in with your Microsoft account.
- Set up your password, fingerprint, or facial recognition as preferred.
- Customize your experience.

**Notes:**

- Depending on the model, some settings might not be available on your computer.
- Do not turn off your computer and ensure it is connected to the ac power during the whole process.

Follow the instructions to set up the operating system.

Step 1. Connect the computer to the ac power and turn it on.

Step 2. Follow the on-screen instructions to complete the operating system setup.

**Related topics**

- “Log in with fingerprint recognition” on page 35
- “Log in with facial recognition” on page 36
- “Set, change, or remove a password” on page 39

---

## Access networks

This section helps you connect to a wireless or wired network.

### Connect to Wi-Fi networks

Click the network icon  on the bottom right of your display to connect to an available network. Provide required information, if needed.

**Note:** The wireless LAN module on your computer might support different standards. For some countries or regions, use of 802.11ax might be disabled according to local regulations.

### Turn on Airplane mode

You might need to turn on Airplane mode if you board an airplane. When Airplane mode is on, all wireless features are turned off automatically. Click the network icon  on the bottom right of your display to turn on Airplane mode.

**Note:** You can enable Wi-Fi networks in this mode according to your actual needs.

## Connect to the wired Ethernet

Connect your computer to a local network through the Ethernet connector on your computer with an Ethernet cable.

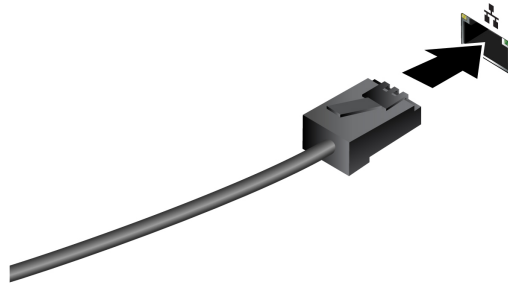

## Connect to a cellular network (for selected models of ThinkPad P16s Gen 3)

To connect a 4G cellular data network, you must have a wireless wide area network (WWAN) module and a nano-SIM card installed. The nano-SIM card might come with your computer by countries or regions. If no nano-SIM card is shipped, you will need to purchase one from authorized service carriers.

### Notes:

- Depending on the model, your computer might have no WWAN module installed.
- The 4G cellular service is provided by authorized mobile service carriers in some countries or regions. You must have a cellular plan from a service carrier to connect to the cellular network. The cellular data plan might vary by location.
- Network connection speeds might also vary by location, environment, network conditions and other factors.

### Establish a cellular connection

This section introduces how to establish a cellular connection.

Step 1. Turn off the computer.

Step 2. Insert a straightened paper clip into the hole in the nano-SIM-card tray. The tray ejects. Install a nano-SIM card as shown and insert the tray into the nano-SIM-card slot. Note the orientation of the card and ensure that it is seated correctly.

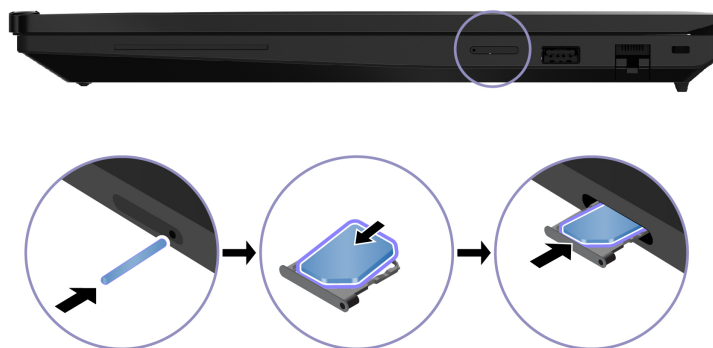

Step 3. Turn on the computer.

Step 4. Click the network icon, and then select the cellular network icon  from the list. Provide required information, if needed.

---

## Interact with your computer











Explore various ways to interact with your computer.

### Use the keyboard shortcuts





Keyboard shortcuts are keys or combinations of keys that provide a quick way to perform particular functions. They help you work more efficiently.

The following tables introduce the functions of keyboard shortcuts.

#### FnLock and function keys

| Key / Key combination   | Function description  |
|---|---|
|   | Switch between the special and standard functions of the function keys (F1–F12).  |
| Fn+FnLock   | Function keys provide two sets of functions: special function and standard function. Icons on the key denote the special function, such as  and  . Characters on the key denote the standard function, such as F1 and F2.<br><br>LED indicator on Esc key indicates which function of the function keys is enabled: <ul style="list-style-type: none"><li>• When the indicator is off, the special function is enabled.</li><li>• When the indicator is on, the standard function is enabled.</li></ul> |
|  | Mute / Unmute (Speakers).   |
|  | Decrease volume.  |
|  | Increase volume.  |
|  | Enable / Disable the microphone.  |
|  | Decrease screen brightness.   |
|  | Increase screen brightness.   |
|  | Select and set up display devices.  |
| Mode  | Change power mode. For more information about power modes, see “Intelligent Cooling” on page 30.  |
| PrtSc   | Print screen.   |
|  | Open Snipping Tool.   |
|  | Open Microsoft® Phone Link.   |
| ☆   | Customize the function of this key on the Vantage app.  |

## Other general keyboard shortcuts

| Key / Key combination   | Function description  |
|---|---|
|      | <ul style="list-style-type: none"><li>• Launch Copilot in Windows.</li><li>• Launch Windows Search.</li></ul> <b>Note:</b> The function varies by countries or regions. |
| Fn+  | Open the context menu of the current active app.  |
| Fn+  | Open the Calculator (for ThinkPad P16s Gen 3).  |
| Fn+  | Put the computer to sleep (for ThinkPad P16s Gen 3).  |
| Fn+  | Adjust the keyboard backlight.  |
| Fn+<  | Go to beginning.  |
| Fn+>  | Go to end.  |
| Fn+Tab  | Open Magnifier.<br><b>Note:</b> Press the Windows logo key+Esc to turn it off.  |
| Fn+4  | Enter sleep mode.   |
| Fn+B  | Break operation.  |
| Fn+K  | Scroll contents.  |
| Fn+P  | Pause operation.  |
| Fn+S  | Send system request.  |
| Fn+N  | Open system information Window.   |
| Fn+G  | Enable / Disable the tapping gesture to launch TrackPoint Quick Menu.   |

You can customize keyboard settings in Vantage app. To customize detailed settings, open the Vantage app, and then click **Device → Input & Accessories**.

For more keyboard shortcuts, go to <https://support.lenovo.com/solutions/windows-support>.

## Use the TrackPoint pointing device

The TrackPoint pointing device enables you to perform all the functions of a traditional mouse, such as pointing, clicking, and scrolling.

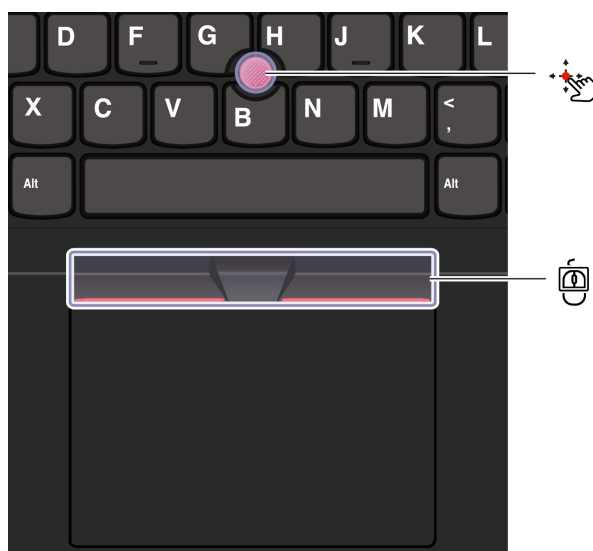

### **TrackPoint pointing stick**

Use your finger to apply pressure to the pointing-stick nonslip cap (hereafter referred to as the red cap) in any direction parallel to the keyboard. The pointer on the screen moves accordingly. The higher the pressure applied, the faster the pointer moves.

### **TrackPoint Three Buttons**

TrackPoint left button and TrackPoint right button correspond to the left and right buttons on a traditional mouse. Press and hold the TrackPoint center button while using your finger to applying pressure to the pointing stick in the vertical or horizontal direction. Then, you can scroll through the document, Web site, or apps.

Press Ctrl+TrackPoint center button+TrackPoint pointing stick at the same time to zoom in or zoom out.

## **Disable the TrackPoint pointing device**

The TrackPoint pointing device is enabled by default. You can disable the device and change settings such as the speed of cursor when using the TrackPoint pointing stick and the TrackPoint center button.

To change the settings, do the following:

- Step 1. Type **Mouse settings** in the Windows search box and then press Enter.
- Step 2. Click **TrackPoint settings** and then follow the on-screen instructions to change the settings.

## **Replace the pointing-stick nonslip cap**

Follow below illustration to replace the pointing-stick nonslip cap.

**Note:** Ensure that the new red cap has grooves **a**.



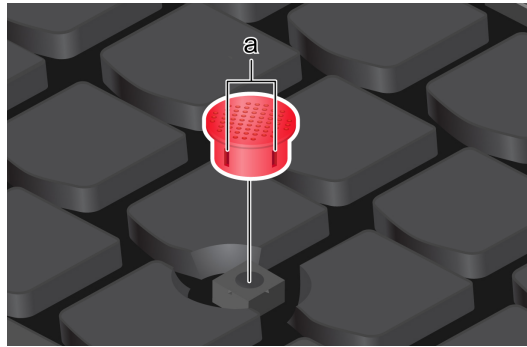

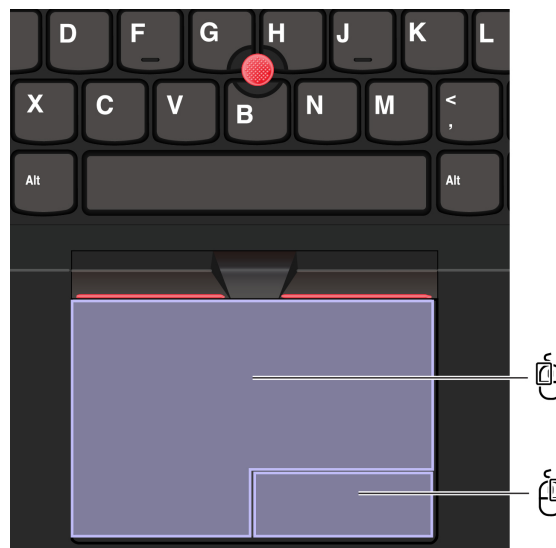

## Use the Trackpad

You can use the Trackpad to perform all the pointing, clicking, and scrolling functions of a traditional mouse. It is ideal for you to use for occasions with high portability requirements, for example, business trips.



| Item  | Description     | Item  | Description      |
|---|-----------------|---|------------------|
|  | Left-click zone |  | Right-click zone |

### Notes:

- Some gestures are not available in the following cases:
  - if the last action was done from the TrackPoint pointing device.
  - when you are using certain apps.
  - when you are using two or more fingers and your fingers are too close.
- Trackpad might be insensitive in the following cases:
  - when you position your fingers too close to the edge of Trackpad.
  - when you touch the Trackpad with wet fingers.
  - if the Trackpad surface is stained with water or oil. Turn off the computer first. Then, gently wipe the Trackpad surface with a soft and lint-free cloth that is moistened with lukewarm water or computer cleaner.

## Use the touch gestures

### Notes:

- When using two or more fingers, ensure that you position your fingers slightly apart.

- Some gestures are not available if the last action was done from the TrackPoint pointing device.
- Some gestures are only available when you are using certain apps.
- If the Trackpad surface is stained with oil, turn off the computer first. Then, gently wipe the Trackpad surface with a soft and lint-free cloth moistened with lukewarm water or computer cleaner.

For more gestures, see the help information of the pointing device.

### One-and-two-finger touch gestures

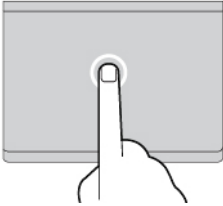
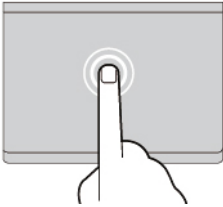
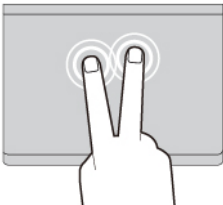
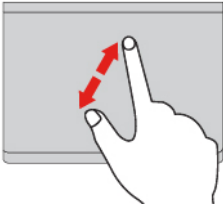
| To do this               | Gesture   |
|--------------------------|---|
| Select an item.          | <p>One finger taps once.</p>             |
| Open an item.            | <p>One finger taps twice.</p>           |
| Display a shortcut menu. | <p>Two fingers tap twice quickly.</p>  |
| Zoom in.                 | <p>Two fingers stretch out.</p>        |

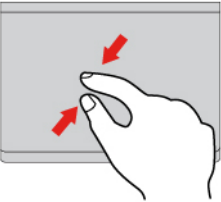
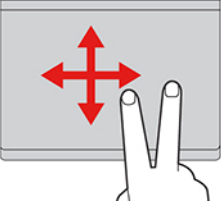
| To do this            | Gesture   |
|-----------------------|---|
| Zoom out.             | <p data-bbox="1036 226 1255 254">Two fingers pinch in.</p>                         |
| Scroll through items. | <p data-bbox="927 516 1365 543">Two fingers slide horizontally or vertically.</p>  |

### Three-and-four-finger touch gestures

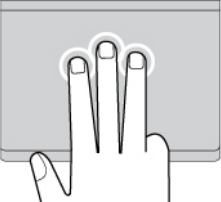
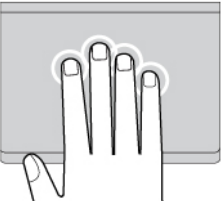
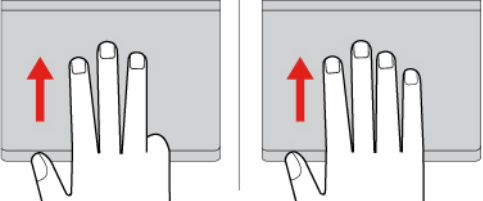
| To do this                | Gesture   |
|---------------------------|---|
| Open search window.       | <p data-bbox="1024 930 1263 957">Three fingers tap once.</p>            |
| Open notification center. | <p data-bbox="1029 1220 1258 1247">Four fingers tap once.</p>          |
| Show all windows.         | <p data-bbox="980 1514 1312 1541">Three- or four-finger swipes up.</p>  |

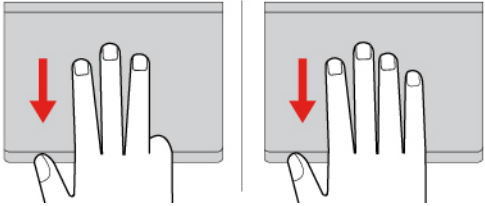
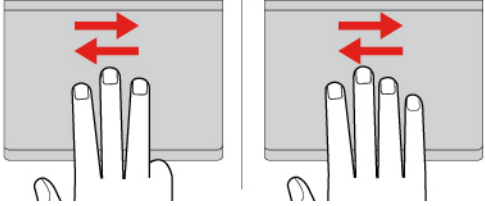
| To do this                           | Gesture  |
|--------------------------------------|--|
| Show the desktop.                    | <p data-bbox="932 226 1295 254">Three- or four-finger swipes down.</p>           |
| Switch between open apps or windows. | <p data-bbox="902 520 1325 548">Three- or four-finger swipes left or right.</p>  |

## Disable the Trackpad

The Trackpad is enabled by default. To disable the device:

- Step 1. Open the **Start** menu, and then click **Settings → Bluetooth & devices → Touchpad**.
- Step 2. In the **Touchpad** section, turn off the **Touchpad** control.

## Use the touch screen (for selected models)

For computers with a touch-enabled screen, you can touch the screen directly with your fingers and interact with computer in a simple way. The following sections introduce frequently used touch gestures.

### Notes:

- Some gestures might not be available when you are using certain apps.
- Do not use gloved fingers or incompatible pens for input on the screen. Otherwise, the touch screen might be not sensitive or does not respond.
- The touch screen is delicate. Do not apply pressure on the screen or touch the screen with anything hard or sharp. Otherwise, the touch panel might malfunction or get damaged.

## One-finger touch gesture

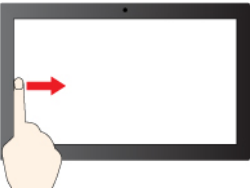
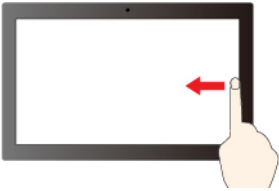
| To do this                | Gesture  |
|---------------------------|--|
| Open a shortcut menu.     | Tap and hold.<br>          |
| Open the widget panel.    | Swipe from the left.<br>   |
| Open notification center. | Swipe from the right.<br> |

## Two-finger touch gesture

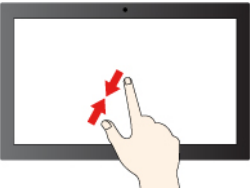
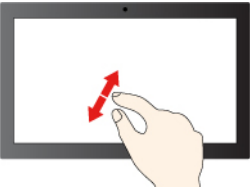
| To do this | Gesture   |
|------------|---|
| Zoom out.  | Move two fingers towards.<br> |
| Zoom in.   | Spread two fingers apart.<br> |

## Three-and-four-finger touch gesture

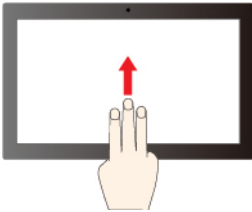
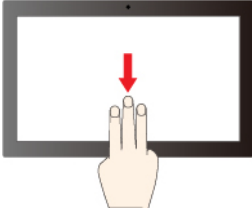
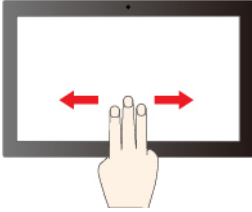
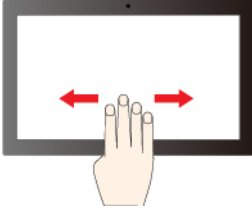
| To do this             | Gesture   |
|------------------------|---|
| Show all open windows. | Swipe with three fingers up.<br>                    |
| Show the desktop.      | Swipe with three fingers down.<br>                  |
| Switch apps.           | Swipe with three fingers to the left or right.<br> |
| Switch desktops.       | Swipe with four fingers to the left or right.<br> |

### Enable three-and-four-finger touch gestures (for selected models)

- Step 1. Type **touchpad** in the Windows search box and then press Enter.
- Step 2. Turn on the **Three-finger gestures** switch or **Four-finger gestures** switch as you desire.

### What to do if the touch screen is not sensitive or does not respond

Follow the instructions to troubleshoot the touch screen.

- Step 1. Turn off the computer.
- Step 2. Use a dry, soft, and lint-free cloth or a piece of absorbent cotton to remove fingerprints or dust from the touch screen. Do not apply solvents to the cloth.
- Step 3. Restart the computer and check if the touch screen works normally.
- Step 4. If the touch screen cannot work normally, type **Windows Update** in the Windows search box and then press Enter.



- Step 5. Follow the on-screen instructions to update Windows.
- Step 6. After updating Windows, check if the touch screen works normally.
- Step 7. If the touch screen still cannot work normally, the touch screen might get damaged. You can call Lenovo Customer Support Center to get further help.

## Connect to an external display

Connect your computer to a projector or a monitor to give presentations or expand your workspace.

### Connect to a wired display

You can connect a wired display with your computer through the USB-C connector or HDMI connector.

If your computer cannot detect the external display, right-click a blank area on the desktop and select **Display settings**. Then follow the on-screen instructions to detect the external display.

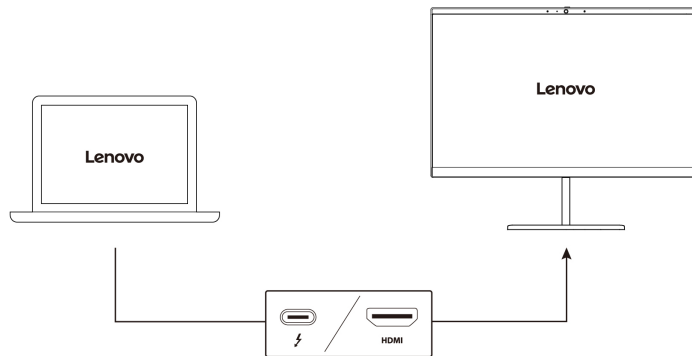

### Supported resolution

The following table lists the supported maximum resolution of the external display.

| Connect the external display to       | Supported resolution |
|---------------------------------------|----------------------|
| USB-C power connector (Thunderbolt 4) | Up to 8K / 60 Hz     |
| HDMI connector                        | Up to 4K / 60 Hz     |

**Note:** The refresh rate higher than 60 Hz can also be supported. If you set the refresh rate higher than 60 Hz, the maximum resolution might be limited.

### Connect to a wireless display

To use a wireless display, ensure that both your computer and the external display support the Miracast® feature.

Press Windows logo key+K and then select a wireless display to connect with.

### Set the display mode

Press or Fn key+ and then select a display mode of your preference.

## Change display settings

You can change the settings for both the computer display and the external display, such as the main or the secondary display, brightness, resolution, and orientation.

To change the settings, do the following:

- Step 1. Right-click a blank area on the desktop and select **Display settings**.
- Step 2. Select the display that you want to configure and change display settings of your preference.

---

## Chapter 3. Explore your computer

This chapter helps you get full use of your computer.

---

### Lenovo apps

This section introduces Lenovo apps that can enrich your computing experience and improve productivity.

#### Lenovo Commercial Vantage (for selected models)

The Lenovo Commercial Vantage app (hereafter referred to as Vantage app) is a customized one-stop solution to help you maintain your computer with automated updates and fixes, configure hardware settings, and get personalized support.

To access the Vantage app, type **Lenovo Commercial Vantage** in the Windows search box.

##### Notes:

- The available features vary depending on the computer model.
- The Vantage app makes periodic updates of the features to keep improving your experience with your computer. The description of features might be different from that on your actual user interface. Ensure that you use the latest version of Vantage app, and apply Windows Update to get the latest updates.

The Vantage app enables you to:

- Know the device status easily and customize device settings.
- Download and install UEFI BIOS, firmware, and driver updates to keep your computer up-to-date.
- Monitor your computer health, and secure your computer against outside threats.
- Scan your computer hardware and diagnose hardware problems.
- Look up warranty status (online).
- Access *User Guide* and helpful articles.
- Temporarily disable the keyboard, screen, trackpad, and TrackPoint pointing device for cleaning.

#### Lenovo View (for selected models)

Lenovo View is an app that enhances camera quality and provides collaboration features for some mainstream video call apps.

##### Access Lenovo View

Type **Lenovo View** in the Windows search box and then press Enter.

##### Explore key features

- **Video Enhancer:** Adjust relevant camera parameters (light, intensity, color) and reduce noise to improve your video call experience. In low light, automatically improve video brightness and colors.

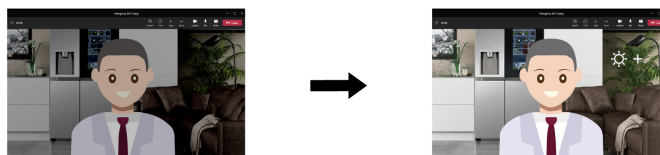

- **Collaboration**

- **Background Removal:** Conceal the background during a video call to keep the focus on you.

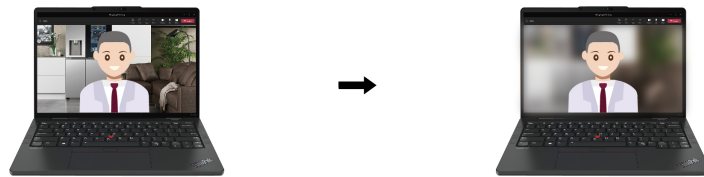

- **Auto-framing:** Automatically keep your face centered in the video call when you move around.

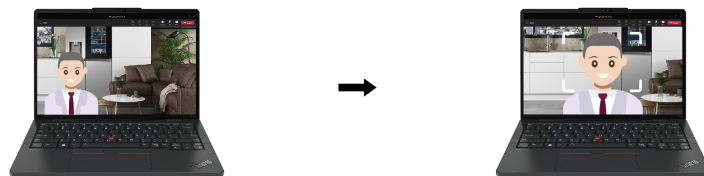

- **Virtual presenter:** Overlay your face on any materials you want to present like a presentation.

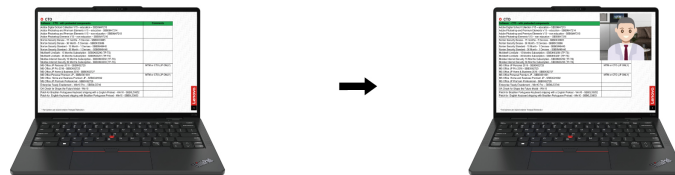

- **Privacy**

- **Privacy Alert:** An alert icon appears on your computer screen when a shoulder surfer appears behind you.

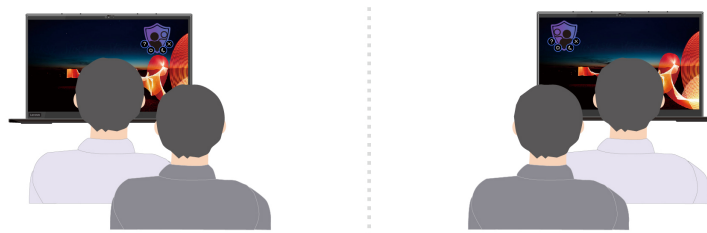

- **Privacy Guard:** Your screen becomes blurred when a shoulder surfer appears behind you. Press Alt +F2 to cancel the blur effect.

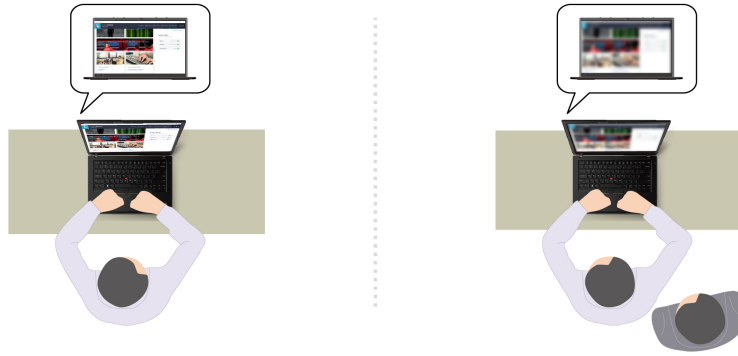

**Note:** For ePrivacy displays, the Privacy Guard function will be enabled automatically when a shoulder surfer appears behind you. Press Alt+F2 to cancel the blur.

- **Wellness**

- **Posture Warning:** Remind you to adjust your posture when you hunch toward the screen.
- **Eye Wellness:** Remind you to look away from the screen and relax your eyes for 20 seconds every 20 minutes.

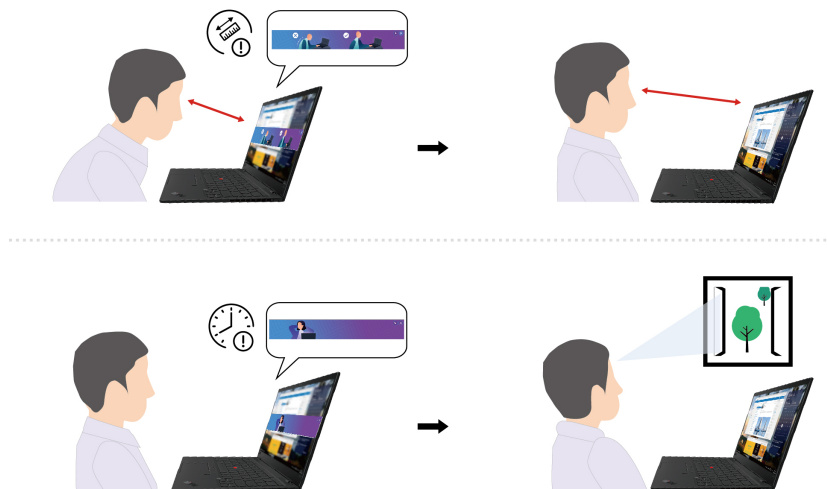

**Notes:**

- The available features vary depending on the computer model.
- The features only work when camera shutter is open.
- Some features might not be able to be used at the same time.
- The Lenovo View app periodically updates features to improve your camera and video call experience. The feature description might be different from that on your actual user interface.

## TrackPoint Quick Menu

TrackPoint Quick Menu is a clickable app. It offers rapid access to functions, such as camera and microphone. You can adjust the function settings in this app.

## Launch the TrackPoint Quick Menu

Double-tap the TrackPoint pointing stick to launch the TrackPoint Quick Menu. You can also set single-tapping as the launch gesture.

**Note:** If the TrackPoint Quick Menu does not pop up after you use the launch gesture, this case might be caused by the displacement of the TrackPoint pointing stick due to too much force applied on it. Wait 15 to 30 seconds and try again.

To change the settings, do the following:

Step 1. Click the flyout ⓘ and click **ADVANCED SETTINGS**.

Step 2. Select **Single-tapping** under **TrackPoint Quick Menu Launch**.

The TrackPoint Quick Menu is enabled by default. Press Fn+G to disable or enable the tapping gesture. When disabled, it cannot be launched by tapping the TrackPoint pointing stick.



## Use the TrackPoint Quick Menu

You can click the edit button ✎ to rearrange the features in the preview panel, or drag and drop the features on the right to the preview panel to customize your quick menu.

- **Camera**

You can adjust the brightness and contrast of the camera, and restore the settings to default by tapping the reset button ↺.

- **Microphone**

You can mute your computer, and adjust the sound effect of your microphone by selecting the following modes:

- Center mode: Capture the speaker's voice.
- Spatial mode: Capture the speaker's voice and the ambience.

**Note:** When internal microphone is not supported by Dolby or the Dolby driver is disabled, an input device list will be displayed instead. The list provides options and one volume bar to test your microphone.

- **Voice typing**

You can convert the speech to text in the text box. Click **START VOICE TYPING** to invoke the text box.

- **Battery**

You can extend the battery lifespan and health by setting the charging threshold below 100%.

To set the threshold, enable the feature and click **ADJUST THRESHOLD**. Then set the charge threshold in the Vantage app.

- **Audio playback**

You can select the output device of your preference and set the volume of your selected channel or mute it.

- **Noise suppression**

You can suppress your own background noise and the noise from other meeting participants.

- Off: Disable noise suppression.
- Low: Suppress low-level background noise.
- High: Suppress all non-speech background noise.

**Note:** The feature does not work when Dolby Voice is off. Click the link in **NOISE SUPPRESSION** to help you enable it.

- **Quick Clean**

You can temporarily disable the keyboard, screen, Trackpad, and TrackPoint pointing device to clean your computer.

**Note:** The features might vary due to periodic updates. For details of the version installed on your computer, click the flyout  at the top-right corner of the page and click **LEARN MORE**.

---

## Color calibration (for selected models of ThinkPad P16s Gen 3)

The factory color calibration feature enables you to render color images or graphics on your display close to the original intent as much as possible.

This feature is available on computer models preinstalled with the X-Rite Color Assistant program.

### Switch between color profiles

For computer with the factory color calibration feature, the color profiles are preinstalled. Follow the instructions to switch between color profiles as desired.

- Step 1. Click the triangular icon in the Windows notification area to show hidden icons. Then, right-click .
- Step 2. Follow the on-screen instructions to select a profile as desired.

### Install or restore color profiles

Lenovo provides backup color profiles in Lenovo Cloud. Follow the instructions to install or restore color profiles in different situations.

#### When color profiles are lost or damaged

If any color profile is lost or damaged, a window will be displayed to remind you to restore the color profiles.

Click **Yes** in the window prompted, and the color profiles will be restored from Lenovo Cloud automatically.

#### When the display has been replaced

If your display has been replaced by a Lenovo-authorized service provider, follow the instructions to install new color profiles.

- Step 1. Connect your computer to the network and close the X-Rite Color Assistant program.

- Step 2. Go to C:\Program files (x86)\X-Rite Color Assistant and locate the ProfileUpdaterForDisplayReplacement.exe file.
- Step 3. Double-click the EXE file. Then, follow the on-screen instructions to input the display serial number and click **Submit**.

When the new color profiles are installed successfully, a window will be displayed.

## When you install a new operating system

If you install a new operating system, follow the instructions to reinstall the color profiles.

- Step 1. Connect your computer to the network and open the preinstalled X-Rite Color Assistant app.

**Note:** If the app is uninstalled, reinstall it by downloading the installation package from <https://support.lenovo.com/downloads/DS540353>.

- Step 2. Go to **Settings** → **Restore profiles**. The app will download and install its unique color profiles from Lenovo cloud automatically.

---

## Intelligent Cooling



The Intelligent Cooling feature helps you adjust power consumption, fan speed, computer temperature, and performance.

**Note:** In balanced mode or best-performance mode, avoid keeping your hands, your lap, or any other part of your body in contact with a hot section of the computer for 10 seconds or longer.

| Mode                  | Recommended scenario   |
|-----------------------|--|
| Best power efficiency | <ul style="list-style-type: none"> <li>You want the computer to be quieter and cooler.</li> <li>You want to maximize the battery life.</li> </ul>  |
| Balanced              | <ul style="list-style-type: none"> <li>You plan to frequently switch between different computer tasks over a period time.</li> <li>You prefer to balance device performance with temperature and fan noise.</li> </ul> |
| Best performance      | <ul style="list-style-type: none"> <li>You want the computer to achieve the best performance.</li> <li>Louder fan noise and higher temperature are acceptable to you.</li> </ul>                                       |

## Switch among modes

You can press F8 or do the following to switch among preferred modes:

- Step 1. Right-click the battery icon in the quick settings area    on the right side of the taskbar.
- Step 2. Click **Power and sleep settings**.
- Step 3. Locate the **Power mode** section and select a preferred mode.

## Install the Intelligent Thermal Solution (ITS) drivers

Follow the instructions to install the Intelligent Thermal Solution (ITS) drivers.



If you reinstall a Windows operating system, the default intelligent cooling settings might be various. It is recommended that you download and install the latest Intelligent Thermal Solution (ITS) driver. To download the ITS driver, do the following:

Step 1. Go to <https://pcsupport.lenovo.com>.

Step 2. Type **Intelligent Thermal Solution driver** in the search box and then press Enter.

Step 3. Select the latest driver and then follow the on-screen instructions to download driver.

---

## Cool and Quiet on lap

The Cool and Quiet on lap feature helps cool down your computer when it becomes hot.

Any extended contact with your body, even through clothing cause discomfort. If you prefer using your computer on the lap, it is recommended that you enable Cool and Quiet on lap feature in UEFI BIOS.

Step 1. Restart the computer. When the logo screen is displayed, press F1 to enter to the UEFI BIOS menu.

Step 2. Click **Config** and turn on the **Cool and Quiet on lap mode** switch.

---

## Manage power

Use the information in this section to achieve the best balance between performance and power efficiency.

### Check the battery status

Check the battery status to help use computer properly.

Go to **Settings** → **System** to check the battery status. For more details about your battery, refer to the Vantage app.

### Charge the computer with ac power

Power source of the ac power adapter:

- Power: 100 W or 135 W
- Sine-wave input at 50 Hz to 60 Hz
- Input rating of the ac power adapter: 100 V to 240 V ac, 50 Hz to 60 Hz
- Output rating of the ac power adapter: 20 V dc, 5 A or 6.75 A

When the battery power is low, charge your battery by connecting your computer to ac power with the supplied power adapter. The 100 W or 135 W ac power adapter supports the rapid charge function, the battery is 80% charged in about one hour when the computer is turned off. The actual charging time depends on the battery size, the physical environment, and whether you are using the computer.

Battery charging is also affected by its temperature. The recommended temperature range for charging the battery is between 10°C (50°F) and 35°C (95°F).

**Note:** Some models might not ship with ac adapters or power cords. Use only the certified adapters and power cords provided by Lenovo that comply with the requirements of relevant national standards to charge the product. It is recommended to use the Lenovo qualified adapters. You can refer to <https://www.lenovo.com/us/en/compliance/eu-doc>.

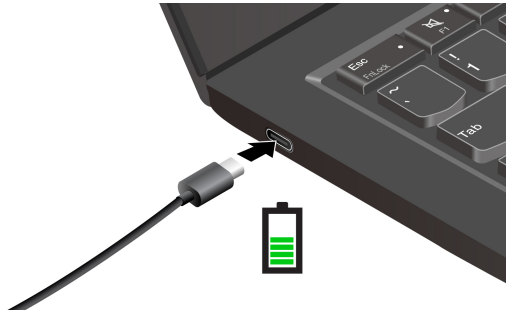

## Maximize the life of the battery

Follow the instructions to maximize the life of the battery.

- Use the battery until the charge is depleted and recharge the battery completely before using it. Once the battery is fully charged, it must discharge to 94% or lower before it will be allowed to recharge again.
- Keep the battery from full charge when it is not in heavy use. For more information, refer to the **Battery settings** tab in the **Power** section of the Vantage app.
- The battery might optimize its full charge capacity based on your usage. After prolonged periods of limited use, full battery capacity might not be available until you discharge to as low as 20% and recharge completely. For more information, refer to the **Battery settings** tab in the **Power** section of the Vantage app.

## Charge your computer with P-to-P 2.0 charging function

Both USB-C connectors (Thunderbolt 4) on the computer feature the Lenovo-unique P-to-P 2.0 (Peer to Peer 2.0) charging function.

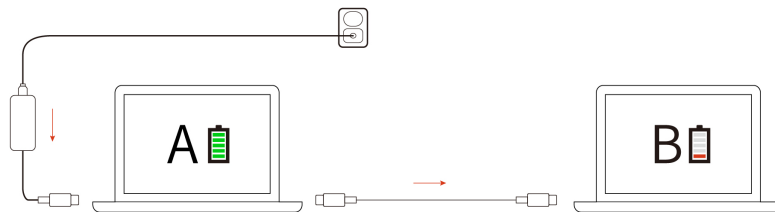

**Note:** The actual charging speed of your computer depends on many factors, such as the remaining battery power of the computers, the wattage of the ac power adapter, and whether you are using the computers.

To use the function, ensure that **Always On USB** and **Charge in Battery Mode** are enabled in UEFI BIOS of your computers, so that the function works even when the computers are off or in hibernation mode. To enable **Always On USB** and **Charge in Battery Mode**:

- Step 1. Restart the computer. When the logo screen is displayed, press F1 to enter to the UEFI BIOS menu.
- Step 2. Click **Config** → **USB**, and then to enable **Always On USB** and **Charge in Battery Mode**.

## Change the power settings

Follow the instructions to change the power settings of your preference.

For ENERGY STAR® compliant computers, the following power plan takes effect by default when your computer is on ac power and has been idle for a specified duration:

- Turn off the display: After 3 minutes
- Put the computer to sleep: After 5 minutes

To change the power plan, the power button function and other settings, do the following:

- Step 1. Go to **Control Panel** and view by Large icons or Small icons.
- Step 2. Click **Power Options**.
- Step 3. Change the settings as you prefer.

---

## Transfer data

Quickly share your files using the built-in Bluetooth or NFC technology among devices with the same features. You also can insert a microSD card or smart card to transfer data.

## Connect to a Bluetooth device

You can connect all types of Bluetooth-enabled devices to your computer, such as a keyboard, a mouse, a smartphone, or speakers. To ensure successful connection, place the devices at most 10 meters (33 feet) from the computer.

### Conventional pair

This topic helps you connect to a Bluetooth device by conventional pair.

- Step 1. Type **Bluetooth** in the Windows search box and then press Enter.
- Step 2. Turn on both the Bluetooth on your computer and the Bluetooth device. Make sure the device is discoverable.
- Step 3. Select the device when it is displayed on the **Add device** list, and then follow the on-screen instructions.

### Swift pair

This topic helps you connect to a Bluetooth device by swift pair.

If your Bluetooth device supports swift pair, do the following:

- Step 1. Enable swift pair notification on Bluetooth settings page.
- Step 2. Turn on both the Bluetooth on your computer and the Bluetooth device. Make sure the device is discoverable.
- Step 3. Click **Connect** when a swift pair notification appears on your computer.

### What to do if the Bluetooth connection failed

Follow the instructions to reconnect a Bluetooth device.

- Step 1. Type **Device Manager** in the Windows search box and then press Enter.
- Step 2. Locate the Bluetooth adapter. Right-click and select **Update driver**.
- Step 3. Select **Search automatically for drivers**, and then follow the on-screen instructions.

## Use a smart card (for selected models)

You can insert a smart card to transfer data.

Supported smart card specifications: 85.60 mm (3.37 inches) x 53.98 mm (2.13 inches)

**Attention:** Smart cards with slits are not supported. Do not insert such a smart card into the smart-card slot of your computer. Otherwise, the reader might get damaged.

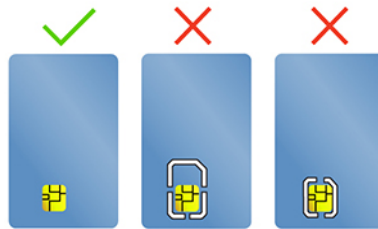

---

## Chapter 4. Secure your computer and information

Your computer can safeguard your privacy and information through some privacy protection functions.

---

### Lock the computer

Lock your computer to a desk, table, or other fixtures through a compatible security cable lock.

**Note:** The slot supports cable locks that conform to the Kensington NanoSaver® lock standards using Cleat™ locking technology. You are responsible for evaluating, selecting, and implementing the locking device and security feature. Lenovo is not responsible for the locking device and security feature. You can purchase the cable locks at <https://smartfind.lenovo.com>.

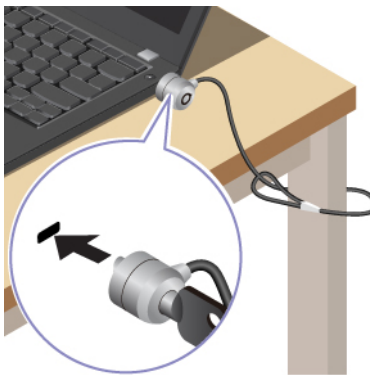

---

### Log in with fingerprint recognition

The fingerprint reader is integrated with the power button. You can power on and log in to the computer with your fingerprint. It eliminates the need to enter complex passwords, saving your time and boosting your productivity.

To enroll your fingerprints, do the following:

- Step 1. Type Sign-in options in the Windows search box and then press Enter.
- Step 2. Select **Fingerprint recognition (Windows Hello)** and then follow the on-screen instruction to enroll your fingerprint.

**Note:** It is recommended that you put your finger at the center of the power button during enrollment and enroll more than one fingerprint in case of any injuries to your fingers. After the enrollment, the fingerprints are associated with the Windows password automatically.

- Step 3. Log in with your fingerprint. When the fingerprint reader indicator is solid green, tap your finger on the fingerprint reader for authentication.

## ThinkPad P14s Gen 5

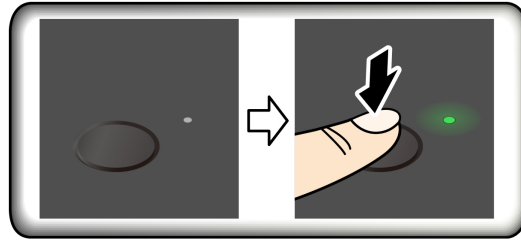

## ThinkPad P16s Gen 3

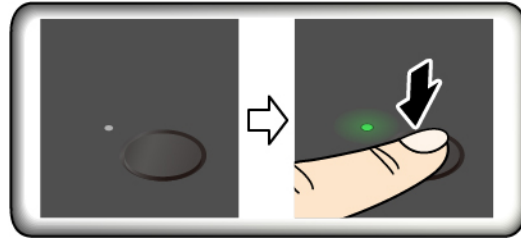

**Note:** You can associate your fingerprints with your power-on password and NVMe password. See “Associate your fingerprints with passwords (for selected models)” on page 40.

### Maintenance tips:

- Do not scratch the surface of the reader with anything hard or sharp.
- Do not use or touch the reader with a wet, dirty, wrinkled, or injured finger.

---

## Log in with facial recognition

You can log in to the computer with your facial recognition. It provides precise and secure authentication.

For models come with a webcam privacy shutter, slide the webcam privacy shutter to uncover the camera lens before using the Windows Hello face recognition.

Set up facial recognition and unlock your computer by scanning your face:

- Step 1. Type **Sign-in options** in the Windows search box and then press Enter.
- Step 2. Select **Facial recognition (Windows Hello)** and then follow the on-screen instruction to enroll your facial ID.

---

## Lock on leave function (for selected models)

Your computer supports the lock on leave function with ultrasound-based human presence detection, providing added security and improving battery life.

**Notes:**

- The lock on leave function does not work if you set the power options to never turn off the display.
- For some countries or regions, the lock on leave function might be disabled according to local regulations.

## Change the settings from the Vantage app

When lock on leave function is enabled in UEFI BIOS, you can change the settings from the Vantage app:

- Step 1. Open the Vantage app, and then click **Device** → **Smart Assist**.
- Step 2. Slide the **Zero Touch Lock** switch to disable or enable the function.

## Change the settings from the UEFI BIOS

To enable or disable lock on leave function in UEFI BIOS menu:

- Step 1. Restart the computer. When the logo is displayed, press F1 to enter the UEFI BIOS menu.
- Step 2. Select **Security** → **Intelligent Security**.
- Step 3. Slide the **User Presence Sensing** switch to enable or disable the function.

---

## Protect data against power loss

NVMe (Non-Volatile Memory express) M.2 solid-state drive features the Lenovo-unique PLP (Power Loss Protection) function to avoid data loss or damage.

If your computer is not responding and you might have to shut down your computer by pressing and holding the power button for several seconds. In this case, the PLP function enables your computer data to be saved timely. However, there is no guarantee that all data is saved in any situation.

To check the type of your M.2 solid-state drive:

- Step 1. Restart the computer. When the logo screen is displayed, press F10 to enter the Lenovo diagnostics window.
- Step 2. On the TOOLS tab, select **SYSTEM INFORMATION** → **STORAGE** using the arrow keys.
- Step 3. Locate the **Device Type** section to check the information.

---

## USB-C Restricted Mode

USB-C Restricted Mode is a security feature that allows you to disable data transfer through USB-C connectors while the charge function of the USB-C connectors is kept. It helps prevent data from being copied from the computer to USB storage devices connected to the computer. By enabling this feature, you can use public USB charging stations, such as those found in cafes and hotel lobbies, without worrying about data leakage from the USB-C connector.

**Notes:**

- Before using this feature, ensure that the remaining battery power is not less than 5%. Otherwise, this feature can not be enabled.
- This feature can be enabled or disabled by key combinations only when the computer is turned on.

To enable or disable this feature, press Fn + U, and then press Fn + S.

After this feature is enabled, the LED indicator blinks briefly when a USB device is connected.



---

## UEFI BIOS passwords

You can set passwords in UEFI (Unified Extensible Firmware Interface) BIOS (Basic Input/Output System) to strengthen the security of your computer.

### Password types

You can set a power-on password, supervisor password, system management password, or NVMe password in UEFI BIOS to prevent unauthorized access to your computer.

However, you are not prompted to enter any UEFI BIOS password when your computer resumes from sleep mode.

### Power-on password

If you set a power-on password, a window is displayed on the screen when you turn on the computer. Enter the correct password to use the computer.

### Supervisor password

The supervisor password protects the system information stored in UEFI BIOS. When entering the UEFI BIOS menu, enter the correct supervisor password in the window prompted. You also can press Enter to skip the password prompt. However, you cannot change most of the system configuration options in UEFI BIOS.

If you have set both the supervisor password and power-on password, you can use the supervisor password to access your computer when you turn it on. The supervisor password overrides the power-on password.

### NVMe passwords

The NVMe password prevents unauthorized access to the data on the storage drive. When an NVMe password is set, you are prompted to type a correct password each time you try to access the storage drive.

- **Single Password**

When a Single NVMe password is set, the user must enter the user NVMe password to access files and applications on the storage drive.

- **Dual Password (User+Admin)**



The admin NVMe password is set and used by a system administrator. It enables the administrator to access any storage drive in a system or any computer connected in the same network. The administrator can also assign a user NVMe password for each computer in the network. The user of the computer can change the user NVMe password as desired, but only the administrator can remove the user NVMe password.

When prompted to enter an NVMe password, press F1 to switch between the admin NVMe password and user NVMe password.

**Notes:** The NVMe password is not available in the following situations:

- A Trusted Computing Group (TCG) Opal-compliant storage drive and a TCG Opal management software program are installed in the computer, and the TCG Opal management software program is activated.
- An eDrive storage drive is installed in the computer preinstalled with the Windows operating system.

## System management password

The system management password can also protect the system information stored in UEFI BIOS like a supervisor password, but it has lower authority by default. The system management password can be set through the UEFI BIOS menu or through Windows Management Instrumentation (WMI) with the Lenovo client-management interface.

You can enable the system management password to have the same authority as the supervisor password to control security-related features. To customize the authority of the system management password through the UEFI BIOS menu:

- Step 1. Restart the computer. When the logo screen is displayed, press F1 to enter the UEFI BIOS menu.
- Step 2. Select **Security → Password → System Management Password Access Control**.
- Step 3. Follow the on-screen instructions.

If you have set both the supervisor password and the system management password, the supervisor password overrides the system management password. If you have set both the system management password and the power-on password, the system management password overrides the power-on password.

## Set, change, or remove a password

Follow the instructions to set, change or remove a password.

Before you start, print these instructions.

- Step 1. Restart the computer. When the logo screen is displayed, press F1 to enter the UEFI BIOS menu.
- Step 2. Select **Security → Password** by using the arrow keys.
- Step 3. Select the password type. Then, follow the on-screen instructions to set, change, or remove a password.

You should record all your passwords and store them in a safe place. If you forget any of your passwords, any potential repair actions required are not covered under warranty.

## What to do if you forget your power-on password

Follow the instructions to remove the power-on password if you forget your power-on password.

If you have set a supervisor password or a system management password and remember it:

- Step 1. Restart the computer. When the logo screen is displayed, immediately press F1.

- Step 2. Type the supervisor password or the system management password to enter the UEFI BIOS menu.
- Step 3. Select **Security → Password → Power-On Password** by using the arrow keys.
- Step 4. Type the current supervisor password or the system management password in the **Enter Current Password** field. Then, leave the **Enter New Password** field blank, and press Enter twice.
- Step 5. In the Changes have been saved window, press Enter.
- Step 6. Press F10 to save changes and exit the UEFI BIOS menu.

If you have not set a supervisor password or a system management password, contact a Lenovo-authorized service provider to have the power-on password removed.

### **What to do if you forget your system management password**

Follow the instructions to remove the system management password if you forget your system management password.

If you have set a supervisor password and remember it:

- Step 1. Restart the computer. When the logo screen is displayed, immediately press F1.
- Step 2. Type the supervisor password to enter the UEFI BIOS menu.
- Step 3. Select **Security → Password → System Management Password** by using the arrow keys.
- Step 4. Type the current supervisor password in the **Enter Current Password** field. Then, leave the **Enter New Password** field blank, and press Enter twice.
- Step 5. In the Changes have been saved window, press Enter.
- Step 6. Press F10 to save changes and exit the UEFI BIOS menu.

If you have not set a supervisor password, contact a Lenovo-authorized service provider to have the system management password removed.

### **What to do if you forget your NVMe password**

Follow the instructions to remove the NVMe password if you forget your NVMe password.

If you forget your NVMe password (Single password) or both user and admin NVMe passwords (Dual password), Lenovo cannot reset your passwords or recover data from the storage drive. You can contact a Lenovo-authorized service provider to have the storage drive replaced. A fee will be charged for parts and service. If the storage drive is a CRU (Customer Replaceable Unit), you can also contact Lenovo to purchase a new storage drive to replace the old one by yourself. To check whether the storage drive is a CRU and the relevant replacement procedure, see “CRU list” on page 49.

### **What to do if you forget your supervisor password**

Follow the instructions to remove the supervisor password if you forget your supervisor password.

There is no service procedure to remove the password. You can contact a Lenovo-authorized service provider to have the system board replaced. A fee will be charged for parts and service.

### **Associate your fingerprints with passwords (for selected models)**

You can associate the fingerprints with passwords to get quick access to the computer and the data on the storage drive without entering the power-on password or NVMe password.

Do the following to associate your fingerprints with the power-on password and NVMe password:

- Step 1. Turn off and then turn on the computer.

- Step 2. When prompted, scan your finger on the fingerprint reader.
- Step 3. Enter your power-on password, NVMe password, or both as required. The association is established.

When you start the computer again, you can use your fingerprints to log in to the computer without entering your Windows password, power-on password, or NVMe password. To change settings, press F1 to enter the UEFI BIOS menu, and then select **Security → Fingerprint**.

**Attention:** If you always use your fingerprint to log in to the computer, you might forget your passwords. Write down your passwords, and keep them in a safe place.

---

## FIDO (Fast Identity Online) authentication

Your computer supports FIDO (Fast Identity Online) authentication feature. This feature works as an alternative to password-based authentication to achieve passwordless authentication.

This feature only works when a power-on password is set in UEFI BIOS and the FIDO2 USB device is registered in ThinkShield™ Passwordless Power-On Device Manager. With this feature, you can input the power-on password or use the registered FIDO2 USB device to power on your computer.

## Register FIDO2 USB device in ThinkShield Passwordless Power-On Device Manager

Follow the instructions to register FIDO2 USB device in ThinkShield Passwordless Power-On Device Manager.

- Step 1. Turn on the computer.
- Step 2. Press F12 during the power-on process.
- Step 3. If you set a power-on password, you are prompted to enter the correct password.
- Step 4. Select **App Menu → ThinkShield Passwordless Power-On Device Manager** and press Enter
- Step 5. Insert the FIDO2 USB device to register the device by following steps:
  - a. Select the available FIDO2 USB device that you want to register in the **Discovered Devices** field.
  - b. Click **Yes** in the displayed window to confirm the device you selected
  - c. If you set a power-on password, you are prompted to enter the correct password.
  - d. The **User operation request** window is displayed. You are prompted to press the button on the connected FIDO2 USB device, and then follow the on-screen instructions to close the window.
  - e. Press Esc to exit and restart your computer.

### Notes:

- If you want to unregister your devices, click the available FIDO2 USB device that you want to unregister in the **My Device** field and enter the correct power-on password for verification.
- If you use more than one FIDO2 USB device with a common identifier for registration, only one device is available.

## Log in to the System with Passwordless Power-On Authentication

Follow the instructions to log in to the System with Passwordless Power-On Authentication.

- Step 1. Restart the computer.

- Step 2. **ThinkShield Passwordless Power-On Authentication** window is displayed.
- Step 3. Insert your registered FIDO2 USB device for detection.
- Step 4. Then follow the on-screen instructions to press the button on your FIDO2 USB device for verification.
- Step 5. After your device is verified, the power-on process continues.

**Note:** You should insert the FIDO2 USB device or enter the power-on password within 60 seconds. Otherwise, your computer will shut down automatically.

---

## Chapter 5. Configure advanced settings

---

### UEFI BIOS

UEFI BIOS is the first program that the computer runs. When the computer turns on, the UEFI BIOS performs a self test to make sure that various devices in the computer are functioning properly.

#### Enter the UEFI BIOS menu

Turn on or restart the computer. When the logo screen is displayed, press F1 repeatedly to enter the UEFI BIOS menu.

#### Navigate the UEFI BIOS menu

Follow the on-screen instructions to navigate in the UEFI BIOS menu.

The table below introduces some available settings of the UEFI BIOS menu. To know more about the UEFI BIOS, for example, BIOS Event log, you can go to <https://pcsupport.lenovo.com> and then type **UEFI BIOS** in search box.

**Note:** The UEFI BIOS menu might vary depending on system configurations.

| Menu             | Introduction  |
|------------------|---|
| <b>Main</b>      | This category displays the general product-related information, such as UEFI BIOS version, machine type, system serial number, preinstalled OS license, and BIOS Event log. |
| <b>Config</b>    | This category enables you to update configurations relating to system settings such as network, USB, keyboard, display, CPU, and power.                                     |
| <b>Date/Time</b> | This category enables you to set computer date and time in this category.   |
| <b>Security</b>  | This category enables you to configure security settings related to such as password, fingerprint, and I/O accessibility.   |
| <b>Startup</b>   | This category enables you to manage settings relevant to booting up.  |
| <b>Restart</b>   | This category enables you to save or discard changes before exiting.  |

You can go to Lenovo BIOS Simulator Center <https://download.lenovo.com/bSCO/index.html> to explore the detailed settings by your product name.

**Note:** The Lenovo BIOS Simulator Center makes periodic updates of the settings. The UEFI BIOS simulator interface and description of settings might be different from that on your actual user interface.

### Customize BIOS Defaults

The feature provides a solution to backup your preferred BIOS Setup settings.

It helps you to save the BIOS Setup settings as customized BIOS default settings, load them to current BIOS settings when needed, and reset the settings to Setup Defaults.

#### Save the customized settings configuration

Follow the instructions to save the customized settings configuration.

Step 1. Restart the computer. When the logo screen is displayed, press F1 to enter the UEFI BIOS menu.

- Step 2. Select **Restart → Save Custom Defaults**.
- Step 3. Click **Yes** to save the settings configuration you customized.

## Load the customized settings configuration

Follow the instructions to load the customized settings configuration.

- Step 1. Restart the computer. When the logo screen is displayed, press F1 to enter the UEFI BIOS menu.
- Step 2. Select **Restart → Load Custom Defaults**.
- Step 3. Click **Yes** to load the customized settings configuration you saved.

You can also press F9 and click **Custom Defaults** to load the customized settings configuration.

**Note:** **Load Custom Defaults** is unavailable if no customized BIOS default settings are saved.

## Reset the settings configuration to Setup Defaults

Follow the instructions to reset the settings configuration to Setup Defaults.

- Step 1. Restart the computer. When the logo screen is displayed, press F1 to enter the UEFI BIOS menu.
- Step 2. Select **Restart → Load Factory Defaults**.
- Step 3. Click **Yes** to reset the settings configuration to Setup Defaults.

You can also press F9 and click **Factory Defaults** to reset the settings configuration to Setup Defaults.

## Reset system to factory defaults

This feature enables you to reset the UEFI BIOS to the factory default settings, including all UEFI BIOS settings and internal system data. It helps you wipe user data in case that you want to dispose of or reuse your computer.

- Step 1. Restart the computer. When the logo screen is displayed, press F1 to enter the UEFI BIOS menu.
- Step 2. Select **Security → Reset System to Factory Defaults** and press Enter.
- Step 3. Several warning windows might be displayed. Do the following before resetting the system to the factory default settings:
  - a. Deactivate the Absolute Persistence Module.
  - b. Remove the NVMe password if you have set one.
- Step 4. For computer models with RAID settings, a window is displayed to remind you of data damage. Select **Yes** to proceed.
- Step 5. A window is displayed to confirm all UEFI BIOS settings will be reset. Select **Yes** to proceed.

**Note:** If the **Intel AMT control** and **Absolute Persistence(R) Module** are permanently disabled, these settings cannot be reset successfully.

- Step 6. Enter the supervisor password, system management password or power-on password in the window prompted.

Your computer will restart immediately. It takes a few minutes to complete the initialization process. Your computer screen might be blank during this process. This is normal and you should not interrupt it.

## Recover the UEFI BIOS

If the UEFI BIOS is corrupted or maliciously attacked, it can self-recover and restore your computer from the last uncorrupted and secure backup. This function protects your computer data.

During the UEFI BIOS self-recovery, the screen might be blank. You can check the progress based on blinking modes of the LED indicators on Esc, F1, and F4. For details, refer to the following table.

**Note:** Do not press the power button to interrupt the progress. Wait a few minutes until the logo screen is displayed.

| Blinking modes  | Self-recovery progress |
|---|------------------------|
| LED indicator on Esc blinks                           | 0% to 32%              |
| LED indicators on Esc and F1 blink simultaneously     | 33% to 65%             |
| LED indicators on Esc, F1 and F4 blink simultaneously | 66% to 100%            |

## Detect memory retraining

Memory retraining is a process to initialize the memory module and run diagnostic tests for the memory module in your computer.

The memory retraining might occur during POST if any of the following situations is detected:

- Memory module replacement
- Total Memory Encryption setting change in the UEFI BIOS
- Memory Reference Code (MRC) change when the UEFI BIOS updates

When memory retraining occurs, the screen might be blank. You might see the LED indicators on Esc, F1, and F4 blinking sequentially to indicate the progress. Do not press the power button to interrupt the process. Wait a few minutes until the logo screen is displayed.

## Cloud bare metal recovery (for selected models)

This feature enables you to remove all user files on your computer and restore the Windows operating system from Cloud (Microsoft® Connected System Recovery). Before using this feature, read the following information.

### Notes:

- This feature will restore your computer to the Windows operating system preinstalled at the factory. Do not use this feature if a customized operating system is installed on your computer, otherwise the customized functions or applications cannot be restored.
- This feature only works with wired network (connected via the Ethernet connector on your computer) and wireless network (WPA2 personal only).

## Restore the Windows operating system

Follow the instructions to restore the Windows operating system.

- Step 1. Restart the computer. When the logo screen is displayed, press F1 to enter the UEFI BIOS menu.
- Step 2. Select **Config** → **Reinstall Windows from Cloud**. Follow the on-screen instructions to enable this feature.
- Step 3. Press F10 to save changes and exit.
- Step 4. The computer will restart automatically. When the logo screen is displayed, press F12.
- Step 5. Select **App Menu** → **Reinstall Windows from Cloud**, and then follow the on-screen instructions.

If the recovery process fails, you still have other options to restore the Windows operating system. For more information, refer to “Recover your Windows operating system” on page 67.

## Update the UEFI BIOS

When you install a new program, device driver, or hardware component, you might need to update the UEFI BIOS.

Download and install the latest UEFI BIOS update package by one of the following methods:

**Note:** During the UEFI BIOS update process, MRC change might cause memory retraining. Memory retraining is a process to initialize the memory module and run diagnostic tests for the memory module in your computer. When memory retraining occurs, the screen might be blank. You might see the LED indicators on Esc, F1, and F4 blinking sequentially to indicate the progress. Do not press the power button to interrupt the process. Wait a few minutes until the logo screen is displayed.

### From the Vantage app

Follow the instructions to update the UEFI BIOS from the Vantage app.

- Step 1. Open the Vantage app, and then click **Device → System Update**.
- Step 2. If the latest UEFI BIOS update package is available, follow the on-screen instructions to download and install the package.

### From the Lenovo Support Web site

Follow the instructions to update the UEFI BIOS from the Lenovo Support Web site.

- Step 1. Go to <https://pcsupport.lenovo.com> and select the entry for your computer.
- Step 2. Click **Drivers & Software → Manual Update → BIOS/UEFI**.
- Step 3. Follow the on-screen instructions to download and install the latest UEFI BIOS update package.

### From the Windows Update

Follow the instructions to update the UEFI BIOS from the Windows Update.

- Step 1. Type **Settings** in the Windows search box and press Enter.
- Step 2. Click **Windows Update → Check for updates**.
- Step 3. If a BIOS update package appears in your update list, click **Download or Install** to initiate the update.

---

## Install a Windows operating system and drivers

Follow the instructions to install a Windows operating system and device drivers.

Microsoft® constantly makes updates to the Windows operating system. Before installing a particular Windows version, check the compatibility list for the Windows version. For details, go to <https://support.lenovo.com/solutions/windows-support>.

### Attention:

- It is recommended that you update your operating system through official channels. Any unofficial update might cause security risks.
- The process of installing a new operating system deletes all the data on your internal storage drive, including the data stored in a hidden folder.

Before you install a Windows operating system, do the following:



1. For models with a Trusted Platform Module, if you are using the Windows BitLocker® Drive Encryption feature, ensure that you have disabled the feature. You can re-enable the feature after the operating system installation is complete.
2. Ensure that the security-related features (Security Chip, Virtualization, and Secure Boot) are enabled.  
To access the security-related features in the UEFI BIOS menu:
  - a. Restart the computer. When the logo screen is displayed, press F1 to enter the UEFI BIOS menu.
  - b. Select **Security** and select the security-related features. Then, press Enter. Ensure that the security-related features are enabled.
  - c. Press F10 to save the settings and exit.
3. Network connection is required to the installation of Windows 11.

Step 1. Connect the drive that contains the operating system installation program to the computer. To create the installation media, refer to <https://support.microsoft.com/windows>.

Step 2. Restart the computer. When the logo screen is displayed, press F1 to enter the UEFI BIOS menu.

Step 3. Select **Startup → Boot** to open the **Boot Priority Order** submenu.

Step 4. Change the startup sequence:

- a. Select the drive that contains the operating system installation program, such as **USB HDD**. Then, press Esc.
- b. Press F10 to save the setting and exit.

**Attention:** After you change the startup sequence, ensure that you select the correct device during a copy, save, or format operation. If you select the wrong device, the data on that device might be erased or overwritten.

**Note:** If the system cannot boot from the selected drive, disable **Secure Boot** and try again. Ensure that you re-enable the feature after the operating system installation is complete.

Step 5. Follow the on-screen instructions to install the device drivers and necessary programs.

## Install device drivers

You should download the latest driver for a component when you notice poor performance from that component or when you added a component. This action might eliminate the driver as the potential cause of a problem. Download and install the latest driver by one of the following methods.

- Open the Vantage app to check the available update packages. Select the update packages you want, and then follow the on-screen instructions to download and install the packages.
- Go to <https://pcsupport.lenovo.com> and select the entry for your computer. Then, follow the on-screen instructions to download and install necessary drivers and software.
- Apply Windows Update to get the latest updates, such as the security patches. Then, follow the on-screen instructions to download and install the necessary updates.



---

## Chapter 6. CRU replacement

This section provides instructions on how to replace Customer Replaceable Units (CRUs).

Customer Replaceable Units (CRUs) are parts that can be replaced by the customer. The computers contain the following types of CRUs:

- **Self-service CRUs:** Refer to parts that can be replaced easily by customer themselves or by trained service technicians at an additional cost.
- **Optional-service CRUs:** Refer to parts that can be replaced by customers with a greater skill level. Trained service technicians can also provide service to replace the parts under the type of warranty designated for the customer's machine.

If you intend on installing a CRU, Lenovo will ship the CRU to you. CRU information and replacement instructions are shipped with your product and are available from Lenovo at any time upon request. You might be required to return the defective part that is replaced by the CRU. When return is required: (1) return instructions, a prepaid shipping label, and a container will be included with the replacement CRU; and (2) you might be charged for the replacement CRU if Lenovo does not receive the defective CRU within thirty (30) days of your receipt of the replacement CRU. For full details, see the Lenovo Limited Warranty documentation at [https://www.lenovo.com/warranty/llw\\_02](https://www.lenovo.com/warranty/llw_02).

---

### CRU list

This topic provides the CRU list of your computer.

#### Self-service CRUs

- ac power adapter\*
- Nano-SIM-card tray (ThinkPad P16s Gen 3 only)\*
- Power cord\*

#### Optional-service CRUs

- Base cover assembly
- Memory module
- M.2 solid-state drive
- M.2 solid-state drive bracket\*
- Wireless WAN module (ThinkPad P16s Gen 3 only)\*

\* for selected models

**Note:** Replacement of any parts not listed above, including the built-in rechargeable battery, should be done by a qualified repair technician or by ensuring that you carefully follow all instructions provided by Lenovo. You can also find Lenovo-authorized repair facilities by going to <https://support.lenovo.com/partnerlocator> for more information.

---

### Before you replace any CRU

Before replacing any CRU, ensure that you disable Fast Startup first and then disable the built-in battery.

## Disable Fast Startup

Follow the instructions to disable Fast Startup.

- Step 1. Go to **Control Panel** and view by Large icons or Small icons.
- Step 2. Click **Power Options**, and then click **Choose what the power buttons do** on the left pane.
- Step 3. Click **Change settings that are currently unavailable** at the top.
- Step 4. If prompted by User Account Control (UAC), click **Yes**.
- Step 5. Clear the **Turn on fast startup** check box, and then click **Save changes**.

## Disable the built-in battery

Follow the instructions to disable the built-in battery.

- Step 1. Restart your computer. When the logo screen is displayed, immediately press F1 to enter the UEFI BIOS menu.
- Step 2. Select **Config → Power**. The **Power** submenu is displayed.
- Step 3. Select **Disable Built-in Battery** and press Enter.
- Step 4. Select **Yes** in the Setup Confirmation window.

The built-in battery is disabled and the computer turns off automatically.

Wait three to five minutes to let the computer cool.

**Note:** If your computer cannot enter the UEFI BIOS menu, you cannot disable the built-in battery. To ensure safety when you replace a CRU, it is recommended to do the following:

- For the built-in battery connected to the system board with cables: Disconnect the battery cables.
- For the CRUable built-in battery connected to the system board with comb connectors: Remove the battery. For the removal procedure, refer to the built-in battery replacement instructions in this documentation.
- For the non-CRUable built-in battery connected to the system board with comb connectors: Call Lenovo Customer Support Center for help.

To check whether the built-in battery on your computer is a CRU, see the CRU list in Chapter 6 “CRU replacement” on page 49.

---

## Replace a CRU

Follow the instructions to replace a CRU.

### Base cover assembly

Follow the instructions to replace the base cover assembly.

Before you start, read [Generic Safety and Compliance Notices](#) and print the following instructions.

**Notes:** Do not remove the base cover assembly in the following situations. Otherwise, there might be a risk of short circuits.

- When your computer has the removable battery installed
- When your computer is connected to ac power

For access, do the following:

1. Disable the built-in battery. See “Disable the built-in battery” on page 50.
2. Turn off the computer and disconnect the computer from ac power and all connected cables.
3. Close the computer display.
4. Remove the nano-SIM-card tray if your computer comes with one. See “Connect to a cellular network (for selected models of ThinkPad P16s Gen 3)” on page 13
5. Turn over the computer.

Step 1. Remove the base cover assembly as shown below.

**Note:** You might need a tool to pry up the base cover assembly.

#### ThinkPad P14s Gen 5

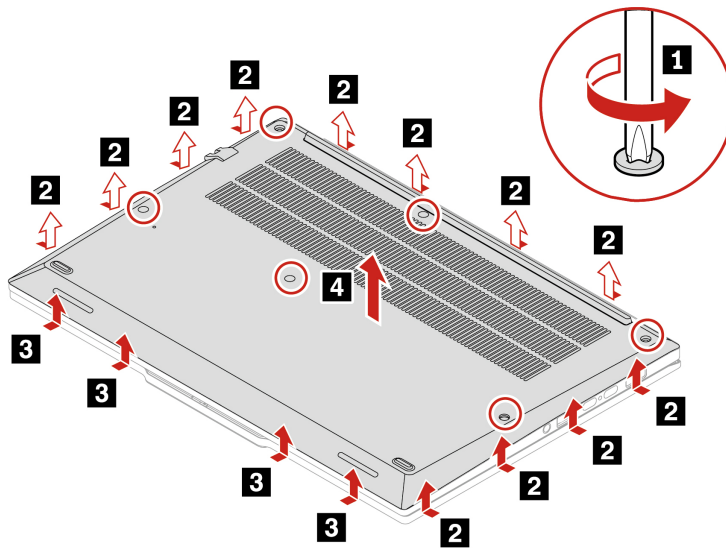

#### ThinkPad P16s Gen 3

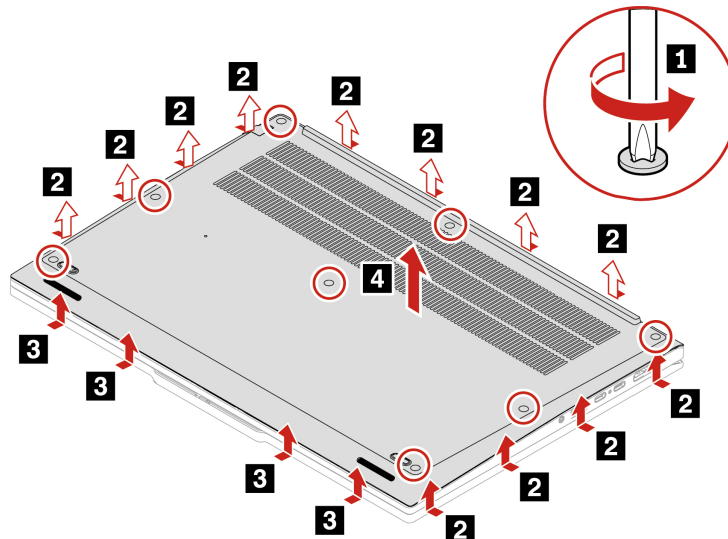

Step 2. Install the base cover assembly as shown below.

### ThinkPad P14s Gen 5

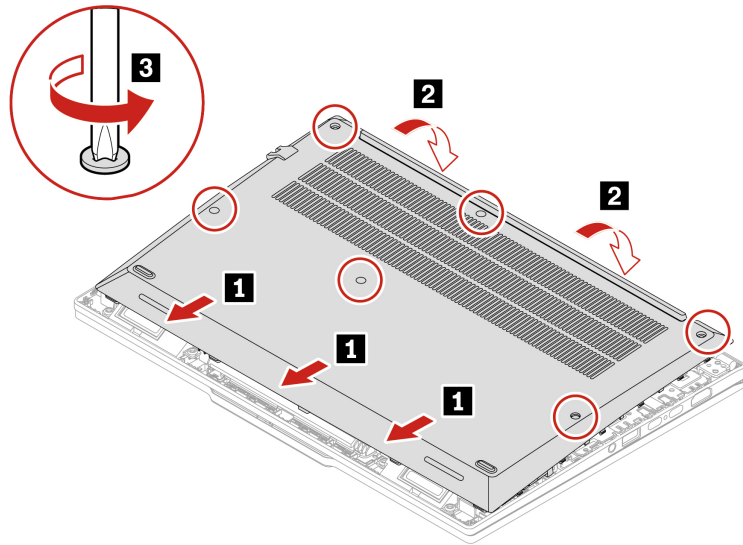

### ThinkPad P16s Gen 3

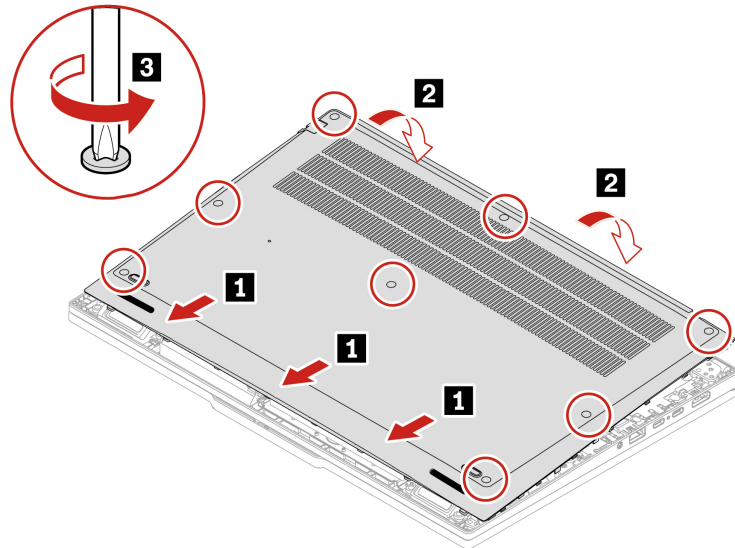

If the computer does not start up after you reinstall the base cover assembly, disconnect the ac power adapter and then reconnect it to the computer.

### Wireless WAN module (for selected models of ThinkPad P16s Gen 3)

Follow the instructions to replace the Wireless WAN module.

The following information is only for the computer with user-installable modules. Ensure that you use only a Lenovo-authorized wireless module specifically tested for this computer model. Otherwise, the computer will generate an error-code beep sequence when you turn on the computer.

Before you start, read [Generic Safety and Compliance Notices](#) and print the following instructions.

**Notes:**

- Wireless WAN ready model identifies that product has preinstalled wireless WAN antennas and allows a user-installable wireless WAN module.
- Only wireless WAN model or wireless WAN ready model is allowed to install the optional Lenovo wireless WAN module.

**Attention:** Do not touch the contact edge of the wireless WAN module. Otherwise, the wireless WAN module might get damaged.

For access, do the following:

1. Disable the built-in battery. See “Disable the built-in battery” on page 50.
2. Turn off the computer and disconnect the computer from ac power and all connected cables.
3. Close the computer display and turn over the computer.
4. Remove the base cover assembly. See “Base cover assembly” on page 50.

Step 1. Remove the wireless WAN module as shown below.

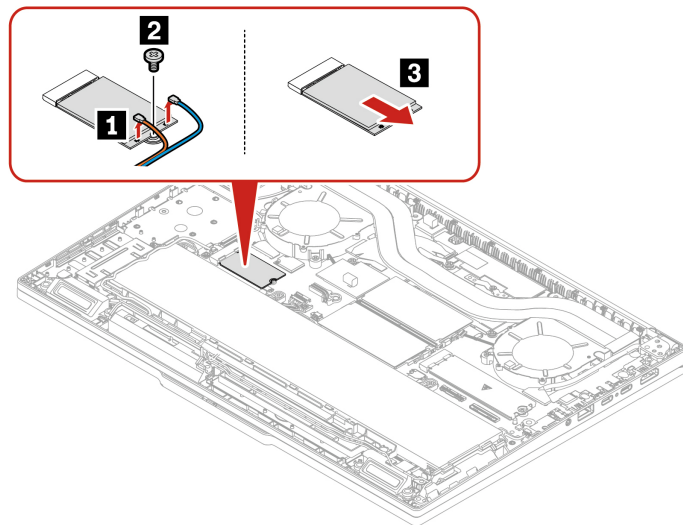

**Note:** A Mylar film might cover the wireless WAN module. To access the wireless WAN module, peel off the film first.

Step 2. Install the wireless WAN module in reverse order. When installing, ensure that you connect the orange cable to the M connector, and the blue cable to the D/G connector.

## Memory module

Follow the instructions to replace the memory module.

Before you start, read [Generic Safety and Compliance Notices](#) and print the following instructions.

**Attention:** Do not touch the contact edge of the memory module. Otherwise, the memory module might get damaged.

For access, do the following:

1. Disable the built-in battery. See “Disable the built-in battery” on page 50.
2. Turn off the computer and disconnect the computer from ac power and all connected cables.
3. Close the computer display and turn over the computer.
4. Remove the base cover assembly. See “Base cover assembly” on page 50.

Step 1. Remove the memory module as shown below.

### ThinkPad P14s Gen 5

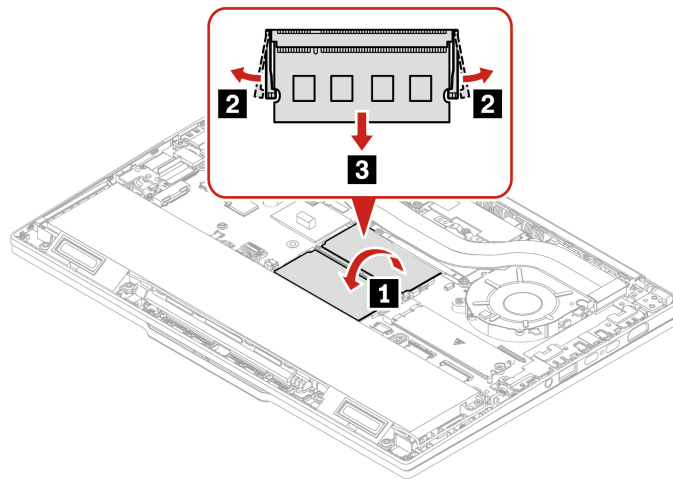

### ThinkPad P16s Gen 3

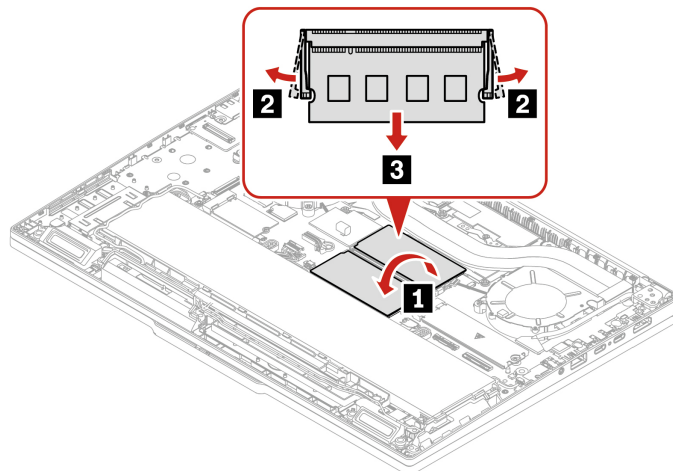

Step 2. Install the memory module as shown below.



## ThinkPad P14s Gen 5

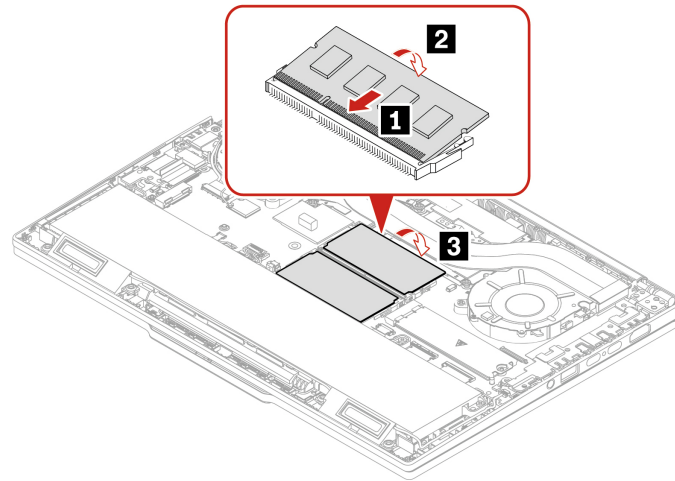

## ThinkPad P16s Gen 3

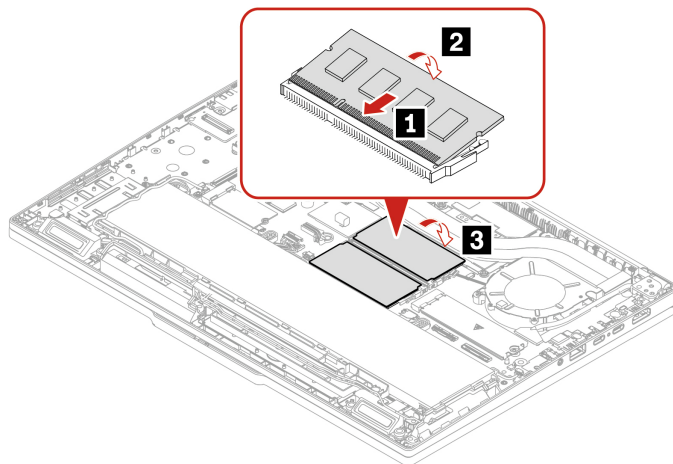

Memory module replacement might cause memory retraining. For details, see “Detect memory retraining” on page 45.

## M.2 solid-state drive and its bracket (for selected models)

Follow the instructions to replace the M.2 solid-state drive.

Before you start, read [Generic Safety and Compliance Notices](#) and print the following instructions.

### Attention:

- If you replace a M.2 solid-state drive, you might need to install a new operating system. For details on how to install a new operating system, see “Install a Windows operating system and drivers” on page 46.
- If your computer is installed with the color profiles, you need to reinstall the color profiles after installing a new operating system, see “Use the factory color calibration feature (for selected models)” on page 29.
- If your computer is installed with a hybrid solid-state drive (with Intel Optane memory), go to [https://support.lenovo.com/docs/tg\\_ssd](https://support.lenovo.com/docs/tg_ssd) to know the details on how to replace it.

The M.2 solid-state drive is sensitive. Inappropriate handling might cause damage and permanent loss of data.

When handling the M.2 solid-state drive, observe the following guidelines:

- Replace the M.2 solid-state drive only for repair. The M.2 solid-state drive is not designed for frequent changes or replacement.
- Before replacing the M.2 solid-state drive, make a backup copy of all the data that you want to keep.
- Do not apply pressure to the M.2 solid-state drive.
- Do not touch the contact edge or circuit board of the M.2 solid-state drive. Otherwise, the M.2 solid-state drive might get damaged.
- Do not subject the M.2 solid-state drive to physical shocks or vibration. Put the M.2 solid-state drive on a soft material, such as cloth, to absorb physical shocks.

For access, do the following:

1. Disable the built-in battery. See “Disable the built-in battery” on page 50.
2. Turn off the computer and disconnect the computer from ac power and all connected cables.
3. Close the computer display and turn over the computer.
4. Remove the base cover assembly. See “Base cover assembly” on page 50.

Step 1. Remove the solid-state drive and its bracket as shown below.

### ThinkPad P14s Gen 5

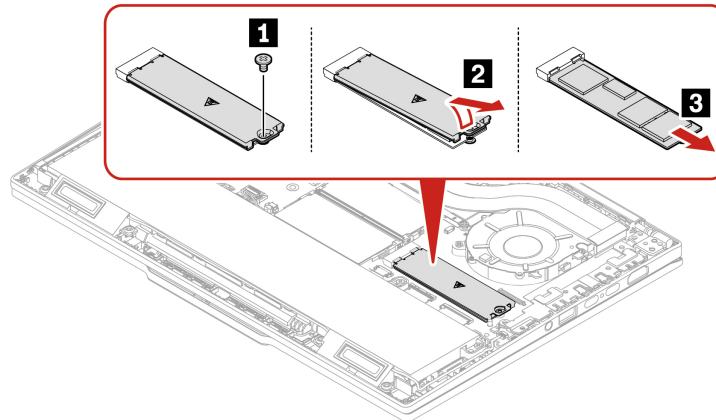

ThinkPad P16s Gen 3

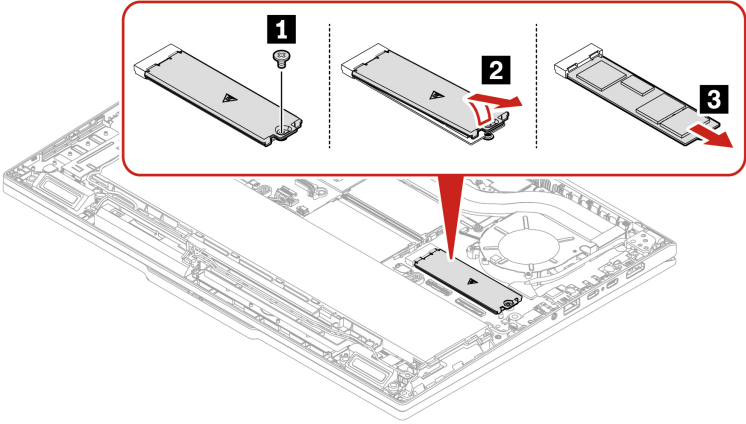

Step 2. Install the solid-state drive and its bracket in reverse order.



---

## Chapter 7. Help and support

This chapter provides solutions to some hardware and software issues.

---

### Find your service QR code and serial number

This topic helps you find service QR code and serial number.

Scan the QR code on the base cover assembly to view the following information:

- Your product information and warranty status
- The latest Lenovo-verified drivers and software
- Troubleshooting and diagnosing solutions when hardware or software issue is encountered
- Customer support center and e-ticket entry for professional support

You can find your serial number via:

- **Dashboard** or **Device** in the **Vantage** app
- Serial-number label of your computer (shown as below illustration)

#### ThinkPad P14s Gen 5

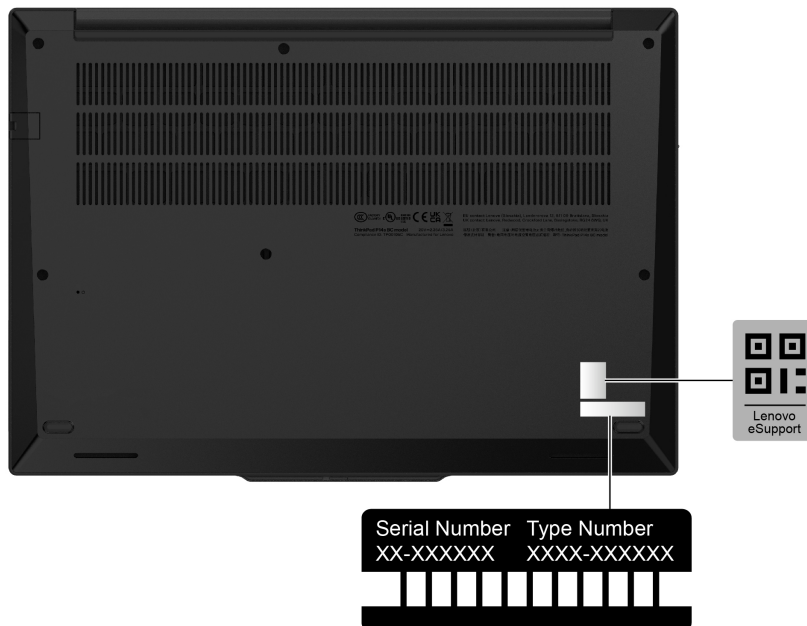

## ThinkPad P16s Gen 3

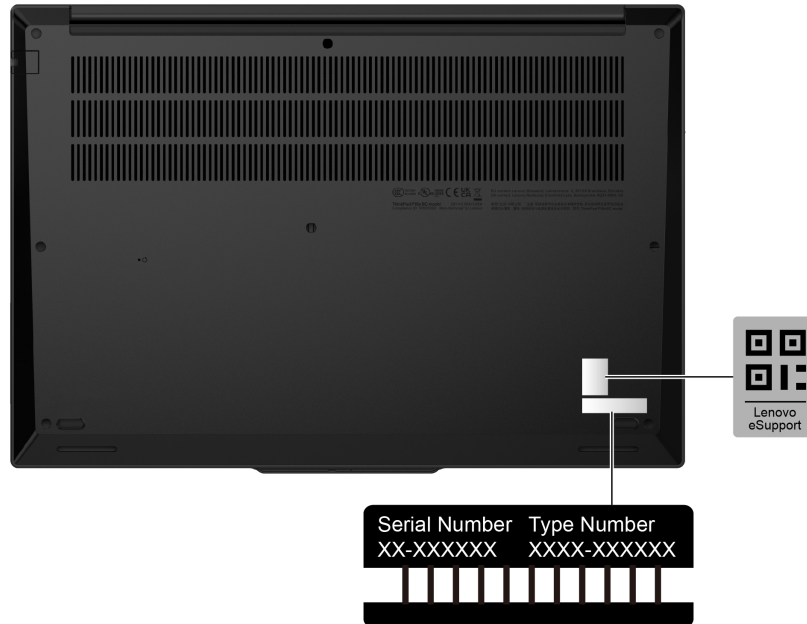

---

## Frequently asked questions

Browse through these FAQs to find answers to commonly raised questions.

| Question                               | Solution   |
|--|--|
| How do I check my repair status?       | <ol style="list-style-type: none"><li>1. Go to Lenovo Support Web site at <a href="https://pcsupport.lenovo.com">https://pcsupport.lenovo.com</a>.</li><li>2. Search by the product name, and navigate to the <b>Repair Status</b> section.</li><li>3. Enter the serial number to check the repair status.</li></ol> |
| How do I check my warranty status?     | <ul style="list-style-type: none"><li>• Go to Lenovo Support Web site at <a href="https://pcsupport.lenovo.com/warrantylookup#/">https://pcsupport.lenovo.com/warrantylookup#/</a>.</li><li>• From the Vantage app.</li></ul>  |
| How do I access <b>Control Panel</b> ? | Type <b>Control Panel</b> in the Windows search box and then press Enter.  |
| How do I turn off my computer?         | Open the <b>Start</b> menu and click <b>Power</b> . Then, click <b>Shut down</b> .   |
| How do I partition my storage drive?   | <a href="https://support.lenovo.com/solutions/ht503851">https://support.lenovo.com/solutions/ht503851</a>  |

| Question   | Solution  |
|--|---|
| <p>What do I do if my computer stops responding?</p>   | <ol style="list-style-type: none"> <li>1. Press and hold the power button until the computer turns off. Then, restart the computer.</li> <li>2. If step 1 does not work: <ul style="list-style-type: none"> <li>• For models with an emergency reset hole: Insert a straightened paper clip into the emergency reset hole to cut off power supply temporarily. Then, restart the computer with ac power connected.</li> <li>• For models without an emergency reset hole: <ul style="list-style-type: none"> <li>– For models with the removable battery, remove the removable battery and disconnect all power sources. Then, reconnect to ac power and restart the computer.</li> <li>– For models with the built-in battery, disconnect all power sources. Press and hold the power button for about seven seconds. Then, reconnect to ac power and restart the computer.</li> </ul> </li> </ul> </li> </ol> |
| <p>What do I do if I spill liquid on the computer?</p> | <ol style="list-style-type: none"> <li>1. Carefully unplug the ac power adapter and turn off the computer immediately. The more quickly you stop the current from passing through the computer the more likely you will reduce damage from short circuits. <p><b>Attention:</b> Although you might lose some data or work by turning off the computer immediately, leaving the computer on might make your computer unusable.</p> </li> <li>2. Wait until you are certain that all the liquid is dry before turning on your computer. <p><b>CAUTION:</b><br/> <b>Do not try to drain out the liquid by turning over the computer. If your computer has keyboard drainage holes on the bottom, the liquid will be drained out through the holes.</b></p> </li> </ol>   |
| <p>How do I enter the UEFI BIOS menu?</p>              | <p>Restart the computer. When the logo screen is displayed, press F1 to enter the UEFI BIOS menu.</p>   |

| Question  | Solution  |
|---|---|
| Where can I get the latest device drivers and the UEFI BIOS?    | <ul style="list-style-type: none"> <li>• From the Vantage app: Open the Vantage app, and then click <b>Device → System Update</b>.</li> <li>• From the Lenovo support Web site:               <ol style="list-style-type: none"> <li>1. Go to <a href="https://pcsupport.lenovo.com">https://pcsupport.lenovo.com</a> and select the entry for your computer.</li> <li>2. Click <b>Driver &amp; Software → Manual Update</b>.</li> </ol> </li> <li>• From the Windows Update:               <ol style="list-style-type: none"> <li>1. Type <b>Settings</b> in the Windows search box and press Enter.</li> <li>2. Click <b>Windows Update → Check for updates</b>.</li> </ol> </li> </ul> <p>If update package is available, follow the on-screen instructions to download and install the package.</p>   |
| What do I do if the LCD goes black when I turn on the computer? | <ol style="list-style-type: none"> <li>1. Run the LCD Self-Test.           <ol style="list-style-type: none"> <li>a. Ensure that the computer is connected to the ac power adapter.</li> <li>b. Press the power button for about seven seconds to turn off the computer.</li> <li>c. Press Fn, left Ctrl, and the power button at the same time.</li> <li>d. Check if the computer displays five solid colors in sequence across the entire screen:               <ul style="list-style-type: none"> <li>• If yes, the LCD functions normally.</li> <li>• If no, the LCD malfunctions.</li> </ul> </li> <li>e. The test lasts for about 20 seconds and then exits automatically. You also can press the power button to exit the test.</li> </ol> </li> <li>2. Contact Lenovo for support and provide the test result. See “Call Lenovo” on page 68.</li> </ol> |



---

## Error messages

An error message is displayed for each error detected in POST or system operation. Refer to the error messages in the table below to solve your computer problems.

If you see a message that is not included in the following table, record the error message first, then shut down the computer and call Lenovo for help. See “Lenovo Customer Support Center” on page 69.

| Message  | Solution   |
|--|--|
| 0190: Critical low-battery error                                     | The computer turned off because the battery power is low. Connect the ac power adapter to the computer and charge the batteries.   |
| 0191: System Security - Invalid remote change requested              | The system configuration change has failed. Confirm the operation and try again.   |
| 0199: System Security - Security password retry count exceeded.      | This message is displayed when you enter a wrong supervisor password more than three times. Confirm the supervisor password and try again.   |
| 0271: Check Date and Time settings.                                  | The date or the time is not set in the computer. Enter the UEFI BIOS menu and set the date and time.   |
| 210x/211x: Detection/Read error on HDDx/SSDx                         | The storage drive is not working. Reinstall the storage drive. If the problem still exists, replace the storage drive.   |
| Error: The non-volatile system UEFI variable storage is nearly full. | <p><b>Note:</b><br/>This error indicates that the operating system or programs cannot create, modify, or delete data in the non-volatile system UEFI variable storage due to insufficient storage space after POST.</p> <p>The non-volatile system UEFI variable storage is used by the UEFI BIOS and by the operating system or programs. This error occurs when the operating system or programs store large amounts of data in the variable storage. All data needed for POST, such as UEFI BIOS setup settings, chipset, or platform configuration data, are stored in a separate UEFI variable storage. Press F1 after the error message is displayed to enter the UEFI BIOS menu. A dialog asks for confirmation to clean up the storage. If you select “Yes”, all data that were created by the operating system or programs will be deleted except global variables defined by the Unified Extensible Firmware Interface Specification. If you select “No”, all data will be kept, but the operating system or programs will not be able to create, modify, or delete data in the storage.</p> <p>If this error happens at a service center, Lenovo-authorized service personnel will clean up the non-volatile system UEFI variable storage using the preceding solution.</p> |







---

## Battery-charge LED indicator diagnosis

The battery-charge LED indicator (hereafter referred to as LED indicator) blinks to help you diagnose and solve some computer problems.



























## Indicator blinking patterns





The LED indicator blinks amber first and then white continually, consisting of different blinking patterns. Each blinking pattern corresponds to an error code. For example, when the LED indicator blinks amber once  and then blinks white twice  , the blinking pattern    corresponds to error code 0001.

### Notes:

- The LED indicator blinks automatically only when the error in the following table occurs.
- The LED indicator blinks continually until the computer turns off. If you need to interrupt the process, press power button for a few seconds.
- We recommend that you speak to our Customer Support Center before attempting to service the computer yourself so that you can be directed to the correct documentation and repair information. It might be recommended to have a Lenovo-authorized service provider repair your computer depending on the complexity of the error or fault.

Refer to the blinking patterns and error codes in the table below to solve your computer problems.

| Blinking patterns   | Error codes   | Solutions  |
|---|---|--|
|      | 0001: Reset error (platform reset not de-asserted)  | <ol style="list-style-type: none"> <li>1. Remove the ac power adapter and the removable battery if your computer has one. Then, reset the computer by doing one of the following: <ul style="list-style-type: none"> <li>• For models with the emergency-reset hole, insert a straightened paper clip into the emergency-reset hole to cut off power supply temporarily. Then, restart the computer with ac power connected.</li> <li>• For models without the emergency-reset hole, press and hold the power button for about seven seconds. Then, reconnect to all power resources and restart the computer.</li> </ul> </li> <li>2. If step 1 does not work, replace the system board (service provider only).</li> </ol> |
|       | 0002: Internal bus error  | Replace the system board (service provider only).  |
|      | 0003: Non-Volatile Memory programming error in system power circuit                         | Replace the system board (service provider only).  |
|      | 0282: Memory module error   | <ol style="list-style-type: none"> <li>1. Reinstall or replace the memory module.</li> <li>2. If step 1 does not work, replace the system board (service provider only).</li> </ol>  |
|       | 0283: PCI resource error  | <ol style="list-style-type: none"> <li>1. Remove PCIe devices (the M.2 card, PCIe card, and so on) (service provider only).</li> <li>2. If step 1 does not work, replace the system board (service provider only).</li> </ol>  |
|      | 0284: TCG-compliant functionality-related error (might be the BIOS code validation failure) | Replace the system board (service provider only).  |

| Blinking patterns  | Error codes   | Solutions   |
|--|---|---|
|   | 0285: TCG-compliant functionality-related error (might be the TPM initialization failure) | Replace the system board (service provider only).   |
|   | 0286: Integrated graphics error   | Replace the system board (service provider only).   |
|   | 0287: Discrete graphics error   | <ol style="list-style-type: none"> <li>1. Reinstall or replace the discrete graphics card (service provider only).</li> <li>2. If step 1 does not work, replace the system board (service provider only).</li> </ol>  |
|   | 0288: Computer display error  | <ol style="list-style-type: none"> <li>1. Reconnect the display cable on both the system board side and the computer display side (service provider only) and check the LCD panel.</li> <li>2. If step 1 does not work, connect an external display to your computer and check the status (customer or service provider). <ul style="list-style-type: none"> <li>• If the external display works, replace the LCD panel (service provider only).</li> <li>• If the external display does not work, replace the system board (service provider only).</li> </ul> </li> </ol> |
|  | 0281: General embedded controller error   | Replace the system board (service provider only).   |

## Lenovo Memory Self Repair (for Intel models only)

Lenovo Memory Self Repair (hereafter referred to as repair tool) enables you to repair memory single-bit or single-row failure with internal redundant resources.

It is recommended that you use the repair tool in the following situations:

- The operating system is unstable, such as having blue screen error or system crash.
- Any application operates abnormally, such as crashing or quitting unexpectedly.
- Any test result indicates memory-related errors.

**Note:** The repair tool can be used only when your computer can be turned on normally.

Step 1. Restart the computer.

Step 2. When the logo screen is displayed, trigger the repair tool by one of the following methods:

- Press F4.
- Press Enter to enter **Startup Interrupt Menu**, and then press F4.
- Press F12 to enter **App Menu**, and then select **Lenovo Memory Self Repair**.

Step 3. Read through the important information in the displayed window and click **Yes** to run the tool.

Step 4. Check the repair result on the pop-up dialog box. There are three types of results.

- **Memory Repaired:** it means that the memory failure is detected and repaired.
- **Memory failure detected but repair was unsuccessful:** it means that the memory failure is detected but cannot be repaired.

- **No failure detected:** it means that no memory failure is detected.

If the issue persists, you can try again or contact Lenovo for additional support.

Step 5. Click **Continue** to turn on the computer.

### Related topics

“Call Lenovo” on page 68

---

## Diagnose and troubleshoot your computer

This section provides introduction to a set of diagnostics and troubleshooting tools at Lenovo Support Web site, the Vantage app, and in your computer. They can help you diagnose common software and hardware issues.

The following table lists these diagnostics tools and the recommended conditions for each tool.

| Diagnosics tool                                      | Recommended scenario   |
|--|--|
| Troubleshoot and diagnose at Lenovo Support Web site | You want to have an online troubleshooting or scan of hardware and drivers on your computer.   |
| Hardware scan  | <ul style="list-style-type: none"> <li>• Your computer is installed with the Vantage app.</li> <li>• You want to perform basic examinations of the hardware components.</li> </ul> |
| UEFI Diagnostics tool                                | <ul style="list-style-type: none"> <li>• You cannot log in to the operating system.</li> <li>• Your computer cannot connect to the network.</li> </ul>                             |

## Troubleshoot and diagnose at Lenovo Support Web site

Lenovo provides two different diagnosing options to help you identify and resolve problems on your computer.

Step 1. Go to <https://www.pcsupport.lenovo.com/> and enter your product name in the search box.

Step 2. Click **Troubleshoot & Diagnose** and select from the following two options depending on your needs.

If you are unsure of the problem with your computer, it is recommended that you select **Easy** and follow on-screen instructions to get your firmware updated and obtain the hardware status.

If you have identified the problem on your computer, you can select **Custom** and follow on-screen instructions to resolve the problem.

### Notes:

- Before launching any automatic diagnosing process, a pop-up window will prompt you to install Lenovo Service Bridge. Lenovo Service Bridge helps to connect your computer with Lenovo diagnosing tools.
- Lenovo Support Web site makes periodic updates of the sections to keep improving your experience with your computer. The Web site interface and descriptions of sections might be different from that on your actual interface.

If solutions cannot resolve problems on your computer, you can follow on-screen instructions to submit an e-ticket or contact Lenovo for professional assistance.

## Hardware scan

Hardware scan is an effective hardware testing tool to help you identify existing hardware issues.

To run the Hardware scan:

- Step 1. Type **Vantage** in the Windows search box and then press Enter.
- Step 2. Click **Hardware scan** or **Support → Hardware scan**.
- Step 3. Select **QUICK SCAN** or **CUSTOMIZE** and then follow the on-screen instructions to run the hardware scan.

### Notes:

- The Quick Scan tool contains a pre-selected suite of tests that performs basic examinations of the hardware components found in the system. The Customize tool enables you to select one or several hardware components to perform the examinations.
- Before selecting **QUICK SCAN**, click **Refresh Modules** to ensure that the list of hardware components is the components currently available for the computer.

- Step 4. If any hardware failure is detected, the result varies depending on the warranty status and varies by country or region. Follow the on-screen instructions to resolve the issue.

## UEFI Diagnostics tool

UEFI Diagnostics tool enables you to view system information and identify hardware issues when you cannot log in to the operating system, or the computer cannot connect to the network.

To use the UEFI Diagnostics tool:

- Step 1. Connect your computer to ac power.
- Step 2. Turn on your computer, and press F10 immediately to enter the UEFI Diagnostics tool.
- Step 3. Follow the on-screen instructions to run the test.
- Step 4. Press Esc to exit the tool. Your computer will restart immediately.
- Step 5. If any hardware failure is detected and you are unable to locate and resolve the problem, you can call Lenovo Customer Support Center. See “Call Lenovo” on page 68.

---

## Recover your Windows operating system

When you encounter some unexpected issues with your operating system, you can choose to recover your operating system by yourself or call Lenovo Customer Support Center.

**Note:** Microsoft constantly makes updates to the Windows operating system. Before installing a particular Windows version, check the compatibility list for the Windows version. For details, go to <https://support.lenovo.com/solutions/ht512575>.

---

| To recover your operating system to... | See...   |
|--|--|
| Factory defaults                       | Refer to the instructions in <a href="https://support.lenovo.com/HowToCreateLenovoRecovery">https://support.lenovo.com/HowToCreateLenovoRecovery</a>   |
| A previous system point                | Refer to the instructions in Popular Topics: <a href="https://support.lenovo.com/solutions/ht118590">https://support.lenovo.com/solutions/ht118590</a> |

---

---

## Self-help resources

Use the following self-help resources to learn more about the computer and troubleshoot problems.

| Resources                 | How to access?  |
|---------------------------|---|
| Lenovo Support Web Site   | <a href="https://pcsupport.lenovo.com">https://pcsupport.lenovo.com</a>   |
| Tips                      | <a href="https://www.lenovo.com/tips">https://www.lenovo.com/tips</a>   |
| Lenovo Community          | <a href="https://forums.lenovo.com">https://forums.lenovo.com</a>   |
| Accessibility information | <a href="https://www.lenovo.com/accessibility">https://www.lenovo.com/accessibility</a>   |
| Windows help information  | <ul style="list-style-type: none"><li>• Open the Start menu and click <b>Get Help</b>.</li><li>• Use Windows Search or the Cortana® personal assistant.</li><li>• Microsoft support Web site: <a href="https://support.microsoft.com">https://support.microsoft.com</a></li></ul> |

---

## Windows label

Windows Genuine Microsoft label indicates the edition of Windows preinstalled on your computer and whether the device is preinstalled with or licensed for genuine Windows.

Your computer might have a Windows Genuine Microsoft label affixed to its cover depending on the following factors:

- Your geographic location
- Edition of Windows that is preinstalled

Go to <https://www.microsoft.com/howtotell/Hardware.aspx> for illustrations of the various types of Genuine Microsoft labels.

- In the People's Republic of China, the Genuine Microsoft label is required on all computer models preinstalled with any edition of the Windows operating system.
- In other countries and regions, the Genuine Microsoft label is required only on computer models licensed for Windows Pro editions.

The absence of a Genuine Microsoft label does not indicate that the preinstalled Windows version is not genuine. For details on how to tell whether your preinstalled Windows product is genuine, refer to the information provided by Microsoft at <https://www.microsoft.com/howtotell/default.aspx>.

There are no external, visual indicators of the Product ID or Windows version for which the computer is licensed. Instead, the Product ID is recorded in the computer firmware. Whenever a Windows product is installed, the installation program checks the computer firmware for a valid, matching Product ID to complete the activation.

In some cases, an earlier Windows version might be preinstalled under the terms of the Windows Pro edition license downgrade rights.

---

## Call Lenovo

If you have tried to correct the problem yourself and still need help, you can call Lenovo Customer Support Center.

## Before you contact Lenovo

Prepare the needed information before you contact Lenovo.

1. Record the problem symptoms and details:
  - What is the problem? Is it continuous or intermittent?
  - Any error message or error code?
  - What operating system are you using? Which version?
  - Which software applications were running at the time of the problem?
  - Can the problem be reproduced? If so, how?
2. Record the system information:
  - Product name.
  - Machine type and “serial number” on page 59.

## Lenovo Customer Support Center

During the warranty period, you can call Lenovo Customer Support Center for help.

### Telephone numbers

For a list of the Lenovo Support phone numbers for your country or region, go to <https://pcsupport.lenovo.com/supportphonenumber> for the latest phone numbers.

**Note:** Phone numbers are subject to change without notice. If the number for your country or region is not provided, contact your Lenovo reseller or Lenovo marketing representative.

### Services available during the warranty period

- Problem determination - Trained personnel are available to assist you with determining if you have a hardware problem and deciding what action is necessary to fix the problem.
- Lenovo hardware repair - If the problem is determined to be caused by Lenovo hardware under warranty, trained service personnel are available to provide the applicable level of service.
- Engineering change management - Occasionally, there might be changes that are required after a product has been sold. Lenovo or your reseller, if authorized by Lenovo, will make selected Engineering Changes (ECs) that apply to your hardware available.

### Services not covered

- Replacement or use of parts not manufactured for or by Lenovo or nonwarranted parts
- Identification of software problem sources
- Configuration of UEFI BIOS as part of an installation or upgrade
- Changes, modifications, or upgrades to device drivers
- Installation and maintenance of network operating systems (NOS)
- Installation and maintenance of programs

For the terms and conditions of the Lenovo Limited Warranty that apply to your Lenovo hardware product, go to:

- [https://www.lenovo.com/warranty/llw\\_02](https://www.lenovo.com/warranty/llw_02)
- <https://pcsupport.lenovo.com/warrantylookup>

---

## Purchase accessories or additional services

This topic provides instructions on how to purchase accessories or additional services.

### Accessories

Lenovo has a number of hardware accessories and upgrades to help expand the functionality of your computer. Accessories include memory modules, storage devices, network cards, power adapters, keyboards, mice, and so on. You can purchase Lenovo accessories at <https://www.lenovo.com/accessories>.

### Additional services

During and after the warranty period, you can purchase additional services from Lenovo at <https://pcsupport.lenovo.com/warrantyupgrade>.

Service availability and service names might vary by country or region.

---

## Accessibility features

Lenovo is committed to making information technology accessible to everyone, including those with hearing, vision, or mobility limitations. Lenovo supports accessibility features in the following ways to help all users better engage with Lenovo products.

### Accessible documentation

Lenovo documentation is designed to meet users' accessibility needs. Users can read the documentation with assistance as needed. For example:

- Text and images are in high contrast. Color contrast can enhance the visual experience. In this mode, all contents are highlighted to be more visible.
- Text is logical and readable. Images are also readable with alternative text provided. A screen reader can enhance the hearing or listening experience. In this mode, all contents are clearer and easier to understand.
- Text is large and clear, making it easier to read. A magnifier can enlarge the text to improve readability.

For more information, watch the video at:

[https://support.lenovo.com/docs/pc\\_pub\\_accessibility](https://support.lenovo.com/docs/pc_pub_accessibility)

### Accessible product design

Lenovo product design also supports accessibility features.

**Note:** The accessibility features vary by product. Depending on the product model, some accessibility features listed below might not be applicable to the product. To get the most up-to-date accessibility information for the product, go to <https://www.lenovo.com/accessibility>. For additional support from Lenovo, users can find phone numbers for their country or region from <https://support.lenovo.com/supportphonenumber>.

- **Keyboards**

Lenovo keyboards support various accessibility features. For example:

- Tactile markings on some keys for easier identification

Tactile markings provide all users with a way to find keys without looking at the keyboard. Lenovo provides bumps for the following keys:

- Function keys: F2 and F3
- Control keys: Fn and Insert



- Typing keys: F, J, and Enter
- Navigation key: Down arrow



- Consistent layout of keyboards for easier use
- Appropriate spacing between keys for typing efficiency
- Sufficient contrast of keys, controls, and labels for better visibility
- On-screen notification or lighted notification for some keys for ease of use
- Keys and controls that can be reached and operated using one hand and require minimal dexterity for ease of use

- **Prominent Communication Bar**

As a welcome addition to your computer, the communication bar incorporates front facing camera options and microphone with 360-degree coverage. It helps you orient computer and open laptop easily.

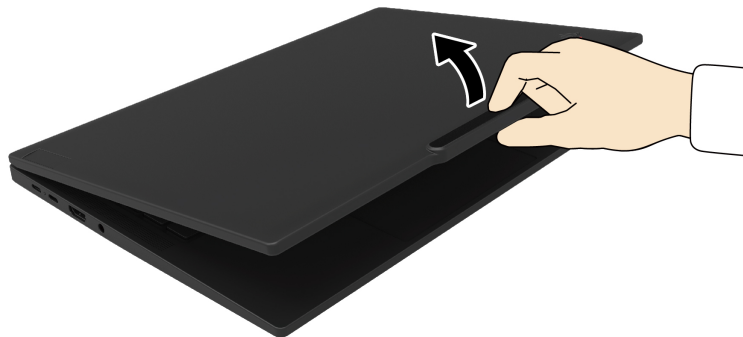

- **Alternative TrackPoint pointing device**

The TrackPoint pointing device comes with TrackPoint pointing stick and TrackPoint Three Buttons. It's a useful alternative for users to interact with the computer without using a traditional mouse. To learn how to use the TrackPoint pointing device, see "Use the TrackPoint pointing device" on page 15

- **Industry-standard connectors**

The industry-standard connectors on Lenovo products enable better compatibility with peripheral devices.

- **Operating systems**

The accessibility features of the operating systems can be configured to assist users in the following ways:

- Vision features, such as text size and visual effect settings, make the screen contents easier to see.
- Hearing features, such as audio and caption settings, make the screen contents easier to hear.
- Interaction features, such as speech and eye-control settings, make the product easier to control.

To access the accessibility features of the Windows 11 operating system, go to **Start → Settings → Accessibility**.

---

## Appendix A. Compliance information

This chapter provides the compliance information of your computer.

For compliance information, refer to *Regulatory Notice* at <https://pcsupport.lenovo.com> and *Generic Safety and Compliance Notices* at [https://pcsupport.lenovo.com/docs/generic\\_notices](https://pcsupport.lenovo.com/docs/generic_notices).

---

### Certification-related information

This section provides certification-related information, such as product name and machine type.

| Product name        | Compliance ID  | Machine type(s) |
|---------------------|--|-----------------|
| ThinkPad P14s Gen 5 | <ul style="list-style-type: none"><li>• TP00156A</li><li>• TP00156A0<sup>1</sup></li><li>• TP00156A1<sup>1</sup></li><li>• TP00156A2<sup>1</sup></li></ul> | 21G2 and 21G3   |
| ThinkPad P16s Gen 3 | <ul style="list-style-type: none"><li>• TP00157A</li><li>• TP00157A0<sup>1</sup></li><li>• TP00157A1<sup>1</sup></li><li>• TP00157A2<sup>1</sup></li></ul> | 21KS and 21KT   |

<sup>1</sup> for India only

Further compliance information related to your product is available at <https://www.lenovo.com/compliance>.

---

### Locate the UltraConnect wireless antennas

Your computer has an UltraConnect™ wireless antenna system. You can enable wireless communication wherever you are.

The following illustration shows the antenna locations on your computer:

## ThinkPad P14s Gen 5



## ThinkPad P16s Gen 3



- 1 Wireless LAN combo antenna (main and auxiliary)
- 2 Wireless WAN antenna (main)\*
- 3 Wireless WAN antenna (auxiliary)\*

\* for selected models

---

## Operating environment

This section provides information about the operating environment of your computer.

### Maximum altitude (without pressurization)

3048 m (10 000 ft)

### Temperature

- Operating: 5°C to 35°C (41°F to 95°F)
- Storage and transportation in original shipping packaging: -20°C to 60°C (-4°F to 140°F)
- Storage without packaging: 5°C to 43°C (41°F to 109°F)

**Note:** When you charge the battery, its temperature must be no lower than 10°C (50°F).

**Relative humidity**

- Operating: 8% to 95% at wet-bulb temperature 23°C (73°F)
- Storage and transportation: 5% to 95% at wet-bulb temperature 27°C (81°F)

---

## Appendix B. Notice for USB connector name update

The USB Implementers Forum published a revision of the guideline for USB connector names in September, 2022. Lenovo follows the revised guideline and updates USB connector names accordingly. You can refer to the table below for naming update details.

| <b>Current name</b>                         | <b>Previous name</b>                |
|---|-------------------------------------|
| USB-A connector (Hi-Speed USB)              | USB-A 2.0 connector                 |
| USB-A connector (USB 5Gbps)                 | USB-A 3.2 Gen 1 connector           |
| USB-A connector (USB 10Gbps)                | USB-A 3.2 Gen 2 connector           |
| USB-A connector (USB 5Gbps, Always On USB)  | Always on USB-A 3.2 Gen 1 connector |
| USB-A connector (USB 10Gbps, Always On USB) | Always on USB-A 3.2 Gen 2 connector |
| USB-C connector (USB 5Gbps)                 | USB-C (3.2 Gen 1) connector         |
| USB-C connector (USB 10Gbps)                | USB-C (3.2 Gen 2) connector         |
| USB-C connector (USB 20Gbps)                | USB 3.2 Gen 2x2                     |
| USB-C connector (USB4 20Gbps)               | USB 4 Gen 2x2                       |
| USB-C connector (USB4 40Gbps)               | USB-C (USB 4) connector             |
| USB-C connector (Thunderbolt 3)             | USB-C (Thunderbolt 3) connector     |
| USB-C connector (Thunderbolt 4)             | USB-C (Thunderbolt 4) connector     |





---

## Appendix C. Notices and trademarks

### Notices

Lenovo may not offer the products, services, or features discussed in this document in all countries. Consult your local Lenovo representative for information on the products and services currently available in your area. Any reference to a Lenovo product, program, or service is not intended to state or imply that only that Lenovo product, program, or service may be used. Any functionally equivalent product, program, or service that does not infringe any Lenovo intellectual property right may be used instead. However, it is the user's responsibility to evaluate and verify the operation of any other product, program, or service.

Lenovo may have patents or pending patent programs covering subject matter described in this document. The furnishing of this document does not give you any license to these patents. You can send license inquiries, in writing, to:

*Lenovo (United States), Inc.  
8001 Development Drive  
Morrisville, NC 27560  
U.S.A.  
Attention: Lenovo Director of Licensing*

LENOVO PROVIDES THIS PUBLICATION "AS IS" WITHOUT WARRANTY OF ANY KIND, EITHER EXPRESS OR IMPLIED, INCLUDING, BUT NOT LIMITED TO, THE IMPLIED WARRANTIES OF NON-INFRINGEMENT, MERCHANTABILITY OR FITNESS FOR A PARTICULAR PURPOSE. Some jurisdictions do not allow disclaimer of express or implied warranties in certain transactions, therefore, this statement may not apply to you.

Changes are made periodically to the information herein; these changes will be incorporated in new editions of the publication. To provide better service, Lenovo reserves the right to improve and/or modify the products and software programs described in the manuals included with your computer, and the content of the manual, at any time without additional notice.

The software interface and function and hardware configuration described in the manuals included with your computer might not match exactly the actual configuration of the computer that you purchase. For the configuration of the product, refer to the related contract (if any) or product packing list, or consult the distributor for the product sales. Lenovo may use or distribute any of the information you supply in any way it believes appropriate without incurring any obligation to you.

The products described in this document are not intended for use in implantation or other life support applications where malfunction may result in injury or death to persons. The information contained in this document does not affect or change Lenovo product specifications or warranties. Nothing in this document shall operate as an express or implied license or indemnity under the intellectual property rights of Lenovo or third parties. All information contained in this document was obtained in specific environments and is presented as an illustration. The result obtained in other operating environments may vary.

Lenovo may use or distribute any of the information you supply in any way it believes appropriate without incurring any obligation to you.

Any references in this publication to non-Lenovo Web sites are provided for convenience only and do not in any manner serve as an endorsement of those Web sites. The materials at those Web sites are not part of the materials for this Lenovo product, and use of those Web sites is at your own risk.

Any performance data contained herein was determined in a controlled environment. Therefore, the result obtained in other operating environments may vary significantly. Some measurements may have been made on development-level systems and there is no guarantee that these measurements will be the same on generally available systems. Furthermore, some measurements may have been estimated through extrapolation. Actual results may vary. Users of this document should verify the applicable data for their specific environment.

This document is copyrighted by Lenovo and is not covered by any open source license, including any Linux® agreement(s) which may accompany software included with this product. Lenovo may update this document at any time without notice.

For the latest information or any questions or comments, contact or visit the Lenovo Web site:

<https://pcsupport.lenovo.com>

### **Trademarks**

Lenovo, Lenovo logo, ThinkPad, ThinkPad logo, and TrackPoint are trademarks of Lenovo. Intel, Intel Optane, and Thunderbolt are trademarks of Intel Corporation or its subsidiaries in the U.S. and/or other countries. Linux is the registered trademark of Linus Torvalds in the U.S. and other countries. Microsoft, Microsoft Teams, Windows, Windows Hello, BitLocker, , and Cortana are trademarks of the Microsoft group of companies. Dolby, Dolby Audio and Dolby Atmos are trademarks of Dolby Laboratories Licensing Corporation. The terms HDMI and HDMI High-Definition Multimedia Interface are trademarks or registered trademarks of HDMI Licensing LLC in the United States and other countries. USB4® and USB-C® are registered trademarks of USB Implementers Forum. Wi-Fi and Miracast are registered trademarks of Wi-Fi Alliance. All other trademarks are the property of their respective owners.